



# ERNEST ORLANDO LAWRENCE BERKELEY NATIONAL LABORATORY

---

## High Performance Building Façade Solutions—Phase II

Eleanor S. Lee, Brian Coffey, Luis Fernandes, Sabine Hoffmann, Andrew McNeil, Anothai Thanachareonkit, and Gregory Ward

Energy Technologies Area  
March 2014



## **Disclaimer**

This report was prepared as the result of work sponsored by the California Energy Commission. It does not necessarily represent the views of the Energy Commission, its employees or the State of California. The Energy Commission, the State of California, its employees, contractors and subcontractors make no warranty, express or implied, and assume no legal liability for the information in this report; nor does any party represent that the uses of this information will not infringe upon privately owned rights. This report has not been approved or disapproved by the California Energy Commission nor has the California Energy Commission passed upon the accuracy or adequacy of the information in this report.

This document was also prepared as an account of work sponsored by the United States Government. While this document is believed to contain correct information, neither the United States Government nor any agency thereof, nor The Regents of the University of California, nor any of their employees, makes any warranty, express or implied, or assumes any legal responsibility for the accuracy, completeness, or usefulness of any information, apparatus, product, or process disclosed, or represents that its use would not infringe privately owned rights. Reference herein to any specific commercial product, process, or service by its trade name, trademark, manufacturer, or otherwise, does not necessarily constitute or imply its endorsement, recommendation, or favoring by the United States Government or any agency thereof, or The Regents of the University of California. The views and opinions of authors expressed herein do not necessarily state or reflect those of the United States Government or any agency thereof or The Regents of the University of California.



# Energy Research and Development Division FINAL PROJECT REPORT

## HIGH PERFORMANCE BUILDING FAÇADE SOLUTIONS – PHASE II

Prepared for: California Energy Commission  
Prepared by: Lawrence Berkeley National Laboratory



Lawrence Berkeley National Laboratory

MARCH 2014  
CEC-500-2015-033

**PREPARED BY:**

**Primary Author(s):**

Eleanor S. Lee  
Brian Coffey  
Luis Fernandes  
Sabine Hoffmann  
Andrew McNeil  
Anothai Thanachareonkit  
Gregory Ward

Lawrence Berkeley National Laboratory  
1 Cyclotron Road, Mailstop 90-3111  
Berkeley, CA 94720  
Phone: 510-486-4997 | Fax: 510-486-4089  
<http://buildings.lbl.gov>

**Contract Number: 500-09-026**

**Prepared for:**

**California Energy Commission**

Dustin Davis  
**Contract Manager**

Virginia Lew  
**Office Manager**  
**Energy Efficiency Research Office**

Laurie ten Hope  
**Deputy Director**  
**ENERGY RESEARCH AND DEVELOPMENT DIVISION**

Robert P. Oglesby  
**Executive Director**

**DISCLAIMER**

This report was prepared as the result of work sponsored by the California Energy Commission. It does not necessarily represent the views of the Energy Commission, its employees or the State of California. The Energy Commission, the State of California, its employees, contractors and subcontractors make no warranty, express or implied, and assume no legal liability for the information in this report; nor does any party represent that the uses of this information will not infringe upon privately owned rights. This report has not been approved or disapproved by the California Energy Commission nor has the California Energy Commission passed upon the accuracy or adequacy of the information in this report.

## **ACKNOWLEDGEMENTS**

This work was supported by the California Energy Commission through its Public Interest Energy Research (PIER) Program on behalf of the ratepayers of California and by the Assistant Secretary for Energy Efficiency and Renewable Energy, Building Technologies Program, of the U.S. Department of Energy, under Contract No. DE-AC02-05CH11231.

### **The authors would like to thank the following supporters of this research project:**

- Dustin Davis, California Energy Commission
- Virginia Lew, California Energy Commission
- Chris Scruton, California Energy Commission
- Marc LaFrance, U.S. Department of Energy
- Karma Sawyer, U.S. Department of Energy
- Amir Roth, U.S. Department of Energy

### **In-kind contributors to this research included:**

- 3M
- Dow Chemical
- General Services Administration
- Glen Raven Custom Fabrics, LLC
- Hunter Douglas/Nysan/Embedia
- LightLouver
- Lutron
- Mechosystems
- MicroShade/Photosolar
- Panelite
- Philips North America
- Pleotint
- Sage Electrochromics, Inc.
- Saint-Gobain
- Schott North America
- View Dynamic Glass

- Viracon
- Wausau Window and Wall Systems
- Zimmer Gunsul Frasca Architects LLP

**The authors would like to thank the following LBNL contributors:**

- Stephen Selkowitz
- Andre Anders, Ph.D.
- Dariush Arasteh
- Walter Buhl
- Cesar Clavero, Ph.D.
- Robert Clear, Ph.D.
- Dragan Charlie Curcija, Ph.D.
- Dennis DiBartolomeo
- Daniel Fuller
- Howdy Goudey
- Carl Jacob Jonsson, Ph.D.
- Joseph H. Klems, Ph.D.
- Christian Kohler
- Kyle Konis, Ph.D.
- Dane Lay
- Robin Mitchell
- Thierry Nouidui, Ph.D.
- Xiufeng Pang, Ph.D.
- David Parker
- Kaustubh Phalak, Ph.D.
- Michael Rubin, Ph.D.
- Dragan Simon Vidanovic
- Michael Wetter, Ph.D.
- Wangda Zuo, Ph.D.

**We would also like to thank the following co-collaborators for their technical contributions to this project:**

- Marilyne Andersen, Ecole Polytechnique Fédérale de Lausanne
- David Appelfeld, Velux Denmark
- Peter Apian-Bennewitz, pab advanced technologies Ltd
- Nicolas Bonneel, Harvard University
- John Breshears, Zimmer Gunsul Frasca Architects LLP
- John Carmody, University of Minnesota
- Denis Fan, E.ON New Build and Technology, UK
- David Geisler-Moroder, University Innsbruck, Austria
- Rob Guglielmetti, National Renewable Energy Laboratory
- Kerry Haglund, Haglund Design, Inc.
- Craig F. Johnson, University of California, San Diego
- Murat Kurt, Ege University, Turkey
- Mark Levi, U.S. General Services Administration
- Mark Perepelitza, Zimmer Gunsul Frasca Architects LLP
- Kevin Powell, U.S. General Services Administration
- John Mardaljevic, Loughborough University, UK
- Mauyra McClintock, MCC Facades
- Christopher Meek, University of Washington
- Richard Mistrick, Pennsylvania State University
- Christoph Reinhart, Massachusetts Institute of Technology
- Kevin Settlemyer, Sustainable IQ, Inc.
- Yao-Jung Wen, Philips North America
- Jan Wienold, Fraunhofer-Institut für Solare Energiesysteme, Freiburg, Germany

## PREFACE

The California Energy Commission Energy Research and Development Division supports public interest energy research and development that will help improve the quality of life in California by bringing environmentally safe, affordable, and reliable energy services and products to the marketplace.

The Energy Research and Development Division conducts public interest research, development, and demonstration (RD&D) projects to benefit California.

The Energy Research and Development Division strives to conduct the most promising public interest energy research by partnering with RD&D entities, including individuals, businesses, utilities, and public or private research institutions.

Energy Research and Development Division funding efforts are focused on the following RD&D program areas:

- Buildings End-Use Energy Efficiency
- Energy Innovations Small Grants
- Energy-Related Environmental Research
- Energy Systems Integration
- Environmentally Preferred Advanced Generation
- Industrial/Agricultural/Water End-Use Energy Efficiency
- Renewable Energy Technologies
- Transportation

*High Performance Building Façade Solutions–Phase II* is the final report for the High Performance Building Façade Solutions–Phase II project (contract number 500-09-026) conducted by the Lawrence Berkeley National Laboratory. The information from this project contributes to Energy Research and Development Division’s Buildings End-Use Energy Efficiency Program.

For more information about the Energy Research and Development Division, please visit the Energy Commission’s website at [www.energy.ca.gov/research/](http://www.energy.ca.gov/research/) or contact the Energy Commission at 916-327-1551.



## ABSTRACT

The High Performance Building Façade Solutions–Phase II project was initiated through the California Energy Commission’s Public Interest Energy Research (PIER) program in July 2010 to support industry’s development and deployment of both incremental and breakthrough façade technologies in partnership with the U.S. Department of Energy (DOE). The objective of this three-year project was to develop, or support the development and deployment of, promising near-term and emerging zero net energy building façade technologies for solar control and daylighting, addressing two of the largest end uses in California commercial buildings: cooling and lighting. In partnership with industry (such as manufacturers), three classes of technologies were investigated: daylighting systems, angular-selective shading systems, and dynamic façade systems. Commercially available and emerging prototype technologies were developed and evaluated using laboratory tests. Simulations, full-scale outdoor tests in the Advanced Window Testbed, and demonstration projects quantified energy and peak electric demand reductions and occupant satisfaction, acceptance, and comfort associated with the resultant indoor environment. Several new technologies were developed using virtual prototyping tools. Integrated control systems were developed using model predictive controls. Simulation tools were developed to model operable complex fenestration systems such as shades and microprismatic films. A schematic design tool called COMFEN was developed to facilitate evaluation of these advanced technologies in the early design phase. All three classes of technologies resulted in significant reductions in perimeter zone energy use and peak electric demand, providing viable options that can support California’s long-term goal of achieving zero net energy use in the next decade.

**Keywords:** daylighting, shading, switchable windows, electrochromics, thermochromics, between-pane shading, exterior shading, microprismatic films, light shelves, motorized shading, automated shading, model predictive controls, daylighting simulation tools, building energy simulation tools, virtual prototyping, complex fenestration systems, bidirectional scattering distribution functions, goniophotometer, window heat transfer, solar-optical properties

Please use the following citation for this report:

Lee, Eleanor S.; Brian Coffey; Luis Fernandes; Sabine Hoffmann; Andrew McNeil; Anothai Thanachareonkit; and Gregory Ward (Lawrence Berkeley National Laboratory). 2014. *High Performance Building Façade Solutions–Phase II*. California Energy Commission. Publication number: CEC-500-2015-033.

# TABLE OF CONTENTS

<b>Acknowledgements</b> .....	<b>i</b>
<b>PREFACE</b> .....	<b>iv</b>
<b>ABSTRACT</b> .....	<b>v</b>
<b>TABLE OF CONTENTS</b> .....	<b>vi</b>
<b>LIST OF FIGURES</b> .....	<b>ix</b>
<b>LIST OF TABLES</b> .....	<b>xi</b>
<b>EXECUTIVE SUMMARY</b> .....	<b>1</b>
Introduction .....	1
Project Purpose.....	1
Project Results.....	2
Project Benefits .....	8
<b>CHAPTER 1: Introduction</b> .....	<b>11</b>
1.1 Background and Approach .....	11
1.1.1 Project Context.....	11
1.1.2 Technical Objectives .....	12
1.1.3 Approach.....	13
1.2 Benefits to California .....	15
1.3 Report Organization .....	15
<b>CHAPTER 2: Daylighting Technologies</b> .....	<b>16</b>
2.1 Introduction .....	16
2.2 Modeling Optically Complex Fenestration Systems.....	17
2.2.1 Overview .....	17
2.2.2 Optical Characterization of CFS.....	21
2.2.3 Computing Daylighting Performance of CFS Using Radiance .....	33
2.2.4 Virtual Prototyping Using Optimization Software .....	38
2.2.5 Modeling Approach for Technology Assessments .....	39
2.3 Technology Research and Development .....	41

2.3.1	Passive Optical Light Shelf .....	41
2.3.2	Switchable Daylight-Redirecting Glazings.....	44
2.3.3	Microprismatic Sunlight-Redirecting Films (3M).....	46
2.3.4	Microprismatic Sunlight-Redirecting Films (Dow Chemical) .....	49
2.3.5	Virtual Prototyping Microprismatic Films .....	49
2.4	Conclusions and Recommendations .....	51
2.4.1	Conclusions.....	51
2.4.2	Recommendations.....	53
2.4.3	Commercialization Potential .....	54
2.4.4	Benefits to California .....	54
<b>CHAPTER 3: Angular-Selective Shading Systems.....</b>		<b>56</b>
3.1	Introduction .....	56
3.2	Modeling Optically Complex Fenestration Systems.....	58
3.2.1	Overview .....	58
3.2.2	Modeling Approach.....	58
3.2.3	Thermal Measurements.....	62
3.2.4	Virtual Prototyping Using Optimization Software .....	64
3.3	Technology R&D.....	66
3.3.1	Commercially Available Between-pane Shading Systems.....	66
3.3.2	Virtual Prototyping of an Angular Selective Shading Layer .....	71
3.3.3	Exterior Shading Systems .....	73
3.4	Conclusions and Recommendations .....	78
3.4.1	Conclusions.....	78
3.4.2	Recommendations.....	80
3.4.3	Commercialization Potential .....	81
3.4.4	Benefits to California .....	82
<b>CHAPTER 4: Dynamic Façades .....</b>		<b>83</b>
4.1	Introduction .....	83

4.1.1	Smart, Building-Integrated Control Systems .....	84
4.1.2	Low-Cost, Dynamic Façade Components .....	87
4.1.3	Implementation and User Acceptance in the Field .....	88
4.2	Building-Integrated Control Systems.....	89
4.2.1	Hardware-in-the-Loop Testing Environment at the Advanced Windows Testbed.....	90
4.2.2	Online MPC: Daylight Maximization Subject to Glare Constraints .....	90
4.2.3	Online MPC: HVAC Energy Minimization (Perimeter Zone System Loads Minimization) .....	92
4.2.4	Offline MPC: Lighting and Under Floor Air Distribution (UFAD) Energy Use Minimization .....	94
4.2.5	Offline MPC: Total Energy Use Minimization with Dynamic Façades + Radiant Cooling .....	98
4.2.6	Offline MPC: Bringing it Together: A Cloud-Based App for Embedded Controllers.....	102
4.3	Dynamic Façade Component R&D .....	109
4.3.1	Switchable Thermochromic Windows .....	109
4.3.2	Near-infrared Switching Thermochromic Windows .....	112
4.3.3	Near-infrared Switching Electrochromic Windows.....	113
4.4	Monitored Demonstrations .....	116
4.4.1	Pilot Demonstration of Sage Electrochromics in Washington, D.C.....	116
4.4.2	Post-occupancy Evaluation of Dimmable Lighting, Automated Shading, and Underfloor Air Distribution System in The New York Times Building .....	117
4.4.3	Design Development of Automated Shading for the Health Sciences Biomedical Research Facility II at the University of California at San Diego .....	119
4.4.4	Monitored Assessment of Daylighting and Manually Operated Shading Systems in the New San Francisco Federal Building .....	123
4.5	Conclusions and Recommendations .....	125
4.5.1	Conclusions.....	125
4.5.2	Recommendations.....	127
4.5.3	Commercialization Potential .....	128
4.5.4	Benefits to California .....	128

<b>CHAPTER 5: Program-wide Market Connections</b> .....	<b>129</b>
5.1 Approach and Goals.....	129
5.2 Outcomes.....	130
5.3 Conclusions and Recommendations.....	131
5.3.1 Conclusions.....	131
5.3.2 Recommendations.....	132
5.3.3 Commercialization Potential.....	133
5.3.4 Benefits to California.....	133
<b>GLOSSARY</b> .....	<b>135</b>
<b>REFERENCES</b> .....	<b>140</b>

## LIST OF FIGURES

Figure 1: Coordinate system for bidirectional measurements and Klems angle basis.....	20
Figure 2: Small-scale goniophotometer.....	22
Figure 3: Scanning goniophotometer.....	23
Figure 4: Schematic of the imaging sphere manufactured by Radiant Zemax.....	24
Figure 5: 145 x 145 Klems basis (left) versus 2° basis projection (right).....	26
Figure 6: Hilbert space-filling curve.....	27
Figure 7: Shirely-Chiu mapping.....	28
Figure 8: Images generated using interpolated BSDF datasets.....	28
Figure 9: Illustration depicting the challenge of interpolating between two incident angles.....	29
Figure 10: Interpolation using Gaussian lobes.....	30
Figure 11: Images generated using three different BSDF representations.....	30
Figure 12: Screen shots of BSDFViewer.....	32
Figure 13: Three-phase method.....	34
Figure 14: Luminance renderings of a perimeter office space created using the three-phase method (left) and five-phase method (right).....	36
Figure 15: Example CFS with proxy geometry.....	37
Figure 16: Floor plan view of the modeled open plan perimeter office.....	40

Figure 17: Exterior elevation of the simulated model..... 40

Figure 18: Klems horizontal angle basis ..... 41

Figure 19: Photographs of passive optical lightshelf in Advanced Windows Testbed..... 42

Figure 20: Luminance maps of passive optical light shelf in Advanced Windows Testbed..... 43

Figure 21: Electroactuated metamaterials for dynamic daylight redirection ..... 45

Figure 22: Model of dynamic prism ..... 46

Figure 23: Daylight distribution from reference and daylight redirecting systems ..... 48

Figure 24: Chart summarizing performance of the 3M P1 and P2 films, the L1 film prototype, commercially available passive optical lightshelf (LightLouver), and venetian blind (VB) ..... 51

Figure 25: Exterior view of LBNL Advanced Windows Testbed with exterior shading systems 56

Figure 26: Transmitted solar radiation on indoor room surfaces..... 60

Figure 27: EnergyPlus workflow for modeling operable shading systems ..... 61

Figure 28: Infrared image of angular selective between glass shading system with a thin film surface heat flux sensor near the center of glass..... 63

Figure 29: Infrared thermography apparatus ..... 63

Figure 30: Iterative process for generating improved angular-selective shading systems ..... 65

Figure 31: Three commercially available angular selective shading systems ..... 66

Figure 32: Total annual source energy use intensity in south-facing perimeter zones of a typical large office building using angular selective shading systems for Burbank, California ..... 68

Figure 33: Total annual source energy use intensity in south-facing perimeter zones of a typical large office building using angular selective shading systems for Oakland, California ..... 69

Figure 34: Shading diagrams for the three different angular selective layers..... 70

Figure 35: Improvements in the performance of an angular-selective shading system ..... 72

Figure 36: Photographs of buildings in California with exterior shades ..... 74

Figure 37: Vertical profiles of eight exterior shading systems..... 75

Figure 38: Total annual source energy use intensity in south-facing perimeter zones of a typical large office building using commercially available exterior shading systems for Burbank climate ..... 77

Figure 39: Total annual source energy use intensity in south-facing perimeter zones of a typical large office building using commercially available exterior shading systems for Oakland climate ..... 78



Figure 40: Illustration of d timestep matrices configuration for a particular case .....	91
Figure 41: Illuminance-maximizing control implementation.....	92
Figure 42: Simulation-based controls framework developed in this study .....	94
Figure 43: Illustration of the control variables considered in this study.....	96
Figure 44: EnergyPlus model and the one-perimeter-zone extraction.....	97
Figure 45: Illustration of the proxy model structure.....	99
Figure 46: Illustration of the two-level optimization structure .....	99
Figure 47: Example shading and cooling control trajectory over a 24-hour prediction horizon	100
Figure 48: Screenshot of Website: Control Logic Constructor Inputs .....	103
Figure 49: Control Logic Constructor Outputs: (a) Desktop application; (b) Python code ready to be run on a Raspberry Pi, which can be embedded in a window unit.....	103
Figure 50: Automated process overview .....	104
Figure 51: Glare constraints construction.....	105
Figure 52: Example optimization results .....	106
Figure 53: Cumulative performance comparison of heuristic and app-constructed controllers	107
Figure 54: Image of a heated thermochromic sample .....	111
Figure 55: Monitored transmitted solar radiation (W/m <sup>2</sup> ) through the thermochromic window .....	112
Figure 56: Residential and commercial source HVAC energy use intensity (EUI) savings from highly dynamic electrochromic glazings compared to optimal static technology .....	115
Figure 57: Interior view of the conference room with upper and lower control zones .....	116
Figure 58: Interior view of the Times Building.....	118
Figure 59: Interior view of a typical daylit laboratory.....	121
Figure 60: Exterior view of a typical daylit laboratory .....	122
Figure 61: Radiance model of laboratory space.....	123

## LIST OF TABLES

Table 1: Summary results of approximated MPC performance in this study showing percentage savings relative to the best available base case controller tested .....	101
--	-----

# EXECUTIVE SUMMARY

## Introduction

In September 2008, the California Public Utilities Commission (CPUC) adopted the California *Long-Term Energy Efficiency Strategic Plan* which defined big, bold initiatives to meet aggressive energy-efficiency and greenhouse gas reduction goals for the residential and commercial building sectors. The plan identified the development and deployment of energy-efficiency technologies as fundamental to California's vision and goals. The plan emphasized that, given the short time frame to reach these goals, a targeted focus was needed to move innovative technologies more quickly into the marketplace. With the new plan, the electric utilities and California Energy Commission (Energy Commission) support was refocused to create "demand pull and set the research agenda for both incremental and game-changing energy-efficiency technology innovations." In February 2009, the American Recovery and Reinvestment Act of 2009 was signed into law by President Barack Obama, providing stimulus funding for energy-efficiency and renewable energy programs to spur technological advances in science, among other activities.

The High Performance Building Façade Solutions–Phase II project was initiated through the California Energy Commission's Public Interest Energy Research (PIER) program in July 2010, to support industry's development and deployment of both incremental and breakthrough façade technologies in partnership with the U.S. DOE. Since window heat gains and lighting energy contribute significantly to both annual energy use intensity and summer peak electric demand in the temperate, sunny climates of California (particularly in inland areas where there has been significant population growth) the project focused on low-cost retrofit technologies such as daylighting and shading attachments. The goal was to achieve near-term, broad market impact, as advocated by California Assembly Bill 758. To address the Energy Commission's zero net energy goals defined by the *California Long Term Strategic Energy Efficiency Plan*, the project also investigated potentially game-changing, dynamic, controllable façade systems. These systems have the potential to respond actively to real-time changes in weather, occupant requirements, and energy demand in concert with controllable lighting and heating, ventilation, and air-conditioning (HVAC) systems. In both development efforts, the project team took an integrated approach to the development of innovative façade technologies. This approach enables reductions in both lighting and HVAC energy use and impact occupant preference, satisfaction, and comfort—as well as indoor environmental quality (as related to health and productivity).

## Project Purpose

The objective of this work was to develop, or support development and deployment of, promising near-term and emerging low energy, high performance building façade technologies for solar control and daylighting, addressing two of the largest end-uses in California commercial buildings: cooling and lighting. Specific performance objectives were to achieve reductions in energy use and peak demand at the perimeter zone at levels of 15–20 percent below Title 24's 2008 requirements with mainstream technologies, and 20–30 percent below

Title 24's 2008 requirements with emerging technologies, while maintaining or improving occupant comfort and amenity.

Market-related objectives were to broaden end-user awareness of the performance benefits associated with emerging fenestration technologies in order to increase market adoption of new energy-efficiency technologies. Third-party data from simulations, field tests, and demonstrations reduce information barriers and serve to define the overall value proposition associated with an energy-efficiency upgrade. Project activities focused on providing such data to stakeholders and decisionmakers and on developing user-friendly tools to facilitate end-user assessments of innovative technologies for specific projects.

## Project Results

### *Simulation Tools*

Most commercially available fenestration systems involve what are called “optically complex” systems where incident light is not transmitted specularly (in the same direction as the incident light) like transparent glass. Light is scattered: transmitting in some directions and reflecting in others, and the pattern of scattering differs as the angle of the sun changes over the course of the day and seasons. At the start of this project, a routine, efficient simulation method was urgently needed to accurately model complex fenestration systems such as roller shades, venetian blinds, sunlight-redirecting louvers, and holographic optical elements. These systems were modeled in the past using either Lambertian (hemispherically diffusing) properties or simplified approximations to emulate the properties of these materials, with minimal reliance on measured data. In addition, a conventionally ray-traced simulation using Radiance, a simulation tool for daylighting systems, would typically take a day or more for a simple space and single point in time, so an annual energy simulation was impractical.

By the conclusion of this project, Lawrence Berkeley National Laboratory (LBNL) had established protocols for measuring and characterizing the light-scattering properties of these systems and had developed, and validated the time-efficient simulation tools (WINDOW, Radiance, and EnergyPlus) needed to evaluate the annual daylighting and window heat gain (and therefore, total energy use) impacts of optically complex fenestration systems. For the prediction of discomfort glare, methods were developed to generate the high-resolution bidirectional transmittance/reflectance data and algorithms needed to calculate the luminance of small-area glare sources such as reflected sunlight off of shiny surfaces. The window and room heat balance calculations in EnergyPlus were modified to accept scheduled values calculated in Radiance so methods used for calculating both daylighting and solar transmission were consistent. Thermal models were also upgraded.

To make these tools more accessible to the end users, a user interface to EnergyPlus and Radiance called COMFEN was developed to target the early design stage when quick decisions are made on the design of the façade. The PC-based tool provides architects and engineers with the capability to conduct side-by-side what-if scenarios and compare the differences in energy use, peak electric demand, comfort, and cost savings. The tool links to WINDOW enabling designers to evaluate optically complex daylighting systems, angular selective shading systems,

and switchable window technologies such as electrochromics and thermochromics. All tools are free to the public for downloading (<http://facades.lbl.gov>), providing Californians and other users worldwide with access to the latest modeling capabilities for advanced window systems.

#### *Virtual Tools for Rapid Prototyping*

The ability to characterize the optical performance of a complex fenestration system by simulation and to quickly simulate annual daylight performance lends itself to iterative design and optimization. There are complex trade-offs between solar control, daylighting, glare control, façade transparency, and view. Lawrence Berkeley National Laboratory's Genopt software can be paired with the new WINDOW, Radiance, and EnergyPlus modeling capabilities to computationally find optimal designs using a combination of parameterization and genetic algorithms. This modeling capability can significantly reduce the cost of early-stage R&D, enabling simultaneous development of prototypes and assessment of energy-savings potential for informed decision-making. A virtual prototyping tool was built first with Radiance and used to develop an alternate set of microprismatic designs based on minimization of lighting energy use and glare. The tool was then extended to incorporate EnergyPlus into the workflow so that both HVAC and lighting energy use could be included in the performance criteria. These tools provide manufacturers with a powerful capability to minimize the lengthy and costly design-test-evaluate cycle needed to develop innovative technologies.

#### *Daylighting Technologies*

Daylight from sidelighting or vertical windows have traditionally only affected, at most, a small portion of the perimeter zone floor area, since it rarely penetrates beyond one to two times the height of the window wall when interior shades are used to control direct sun and glare. With advancements in technology, daylight can be extended deeper into the perimeter zone and provide supplemental temporal lighting in the core zone of buildings. In California, where clear sky conditions predominate and the cost of electricity is high, the technical and market potential of these technologies are more promising than some other areas of the United States.

#### *Passive optical lightshelves, LightLouver*

The performance of a passive optical light shelf (LightLouver LLC) was benchmarked at the start of the project using newly developed and validated Radiance modeling tools. Simulations of an open plan office zone with the light shelf installed in the upper clerestory region of the window and a conventional shade in the lower view window indicated annual lighting energy savings of 20 percent, compared to a non-daylit perimeter zone. Discomfort glare was well controlled: less than 1 percent occurrence of glare over the year. The system was field tested. It was also used to daylight an open plan office area in an existing office building in Sacramento. Anecdotal comments from the occupants a year later indicated satisfaction with the lighting quality in the space, despite the reduced access to view.

#### *Microprismatic films, 3M*

Microstructured windows films are a relatively mature technology that are applicable to the retrofit market at low cost. Samples of a pre-commercial film were measured using optical

imaging and a scanning goniophotometer, which measures light from an object at different angles. Early simulations and field test measurements indicated that the original design would result in significant glare so the design was modified to improve performance. Annual source lighting energy savings of the office zone installed with the second film was 37-41 percent compared to a Title 24 2008 compliant, non-daylit perimeter zone in Sacramento. Source peak electric demand reductions were 27-49 percent. Estimated simple payback ranged from two to six years, assuming an added installed cost of \$20 per square foot (ft<sup>2</sup>) of window area to the consumer. 3M is continuing to develop the product and promote its market adoption.

#### *Microprismatic films, Dow Chemical*

LBNL partnered with Dow Chemical to demonstrate how the new Radiance modeling tools can help industry accelerate development of new prototype technologies. Dow Chemical voiced strong appreciation for the technical support, saying that the new modeling capabilities were invaluable for informed internal decisionmaking. Other industry partners have since voiced the same appreciation for the benefits the new modeling tools have brought to their business.

#### *Angular-Selective Shading Systems*

Angular-selective shading systems block or filter direct sunlight and admit reflected sunlight, diffuse skylight, or ground-reflected daylight within a specific range of incident solar angles. Whether in an exterior or between-pane configuration, these systems have the potential to achieve a more optimal balance between solar control and daylighting, and therefore deliver greater energy and peak electric demand savings when tailored to a specific façade orientation and latitude.

#### *Between-pane shading: Panelite, Microshade, and Schott North America*

Between-pane, static or non-operable angular-selective shading systems have the advantage of being protected from the elements by at least one pane of glass. This means higher potential durability and also obviates the need for cleaning. An initial investigation was conducted to determine the energy savings potential of three commercially available, static, angular selective shading systems in the perimeter zones of a typical large commercial office building. EnergyPlus results indicated significant technical potential, especially if the shading layer does not increase the insulating glass unit's thermal conductance. Annual source energy use savings from the three systems were 16-40 percent compared to the Title 24 2008 code-compliant window without daylighting controls and 14-24 percent compared to the Title 24 2013 compliant window with daylighting controls. Peak window heat gains were also significantly reduced.

An alternate design for the Panelite system was developed. Both geometric and optical properties were parameterized, resulting in a 22 percent improvement in annual energy performance compared to an original Panelite design. There are complex trade-offs between solar control, daylighting, façade transparency, and view. The microperforated screen system provided an acceptable balance between all four of these objectives, minimally obstructing

views out. All systems, however, will require an indoor shade to control discomfort glare, primarily to obstruct low-angle sunlight.

*Exterior shading: KoolShade, WAREMA, Clauss-Markisen, Schott North America, Serge Ferrari*

Exterior static, coplanar shades are reputed to be superior for solar control and also can be effective for daylighting and glare management. A simulation study using EnergyPlus found annual energy use decreased as window area was increased if fixed exterior shades and daylighting controls were used. Relative to the Title 24 code, exterior shades produced significant reductions in annual energy use for moderate- to large-area windows: 17-42 percent savings compared to the 2008 code and 15-30 percent savings compared to the 2013 code.

All systems maintained peak window heat gains well below the 4 W/ft<sup>2</sup>-floor maximum for small- to large-area windows, enabling use of low-energy cooling strategies. Most exterior shading systems are limited in applicability to low- and mid-rise buildings of no more than about five stories tall due to wind loads. For retrofit applications in low-rise buildings, the lightweight screens for moderate-area windows like KoolShade can be clipped at the edge to the outside window frame at fairly low cost, similar to an insect screen. These too need regular cleaning. If combined with upgrades to the lighting (e.g., light-emitting diodes with daylighting controls) and HVAC upgrades, this integrated package could result in significantly lower perimeter-zone energy use and synergistic cost reductions due to downsizing of the HVAC system (e.g., chiller plant, variable air volume [VAV] delivery systems).

*Dynamic Façades*

Static façade systems cannot always provide the optimal envelope response to the immediate environmental conditions. With this in mind, the future design of high-performance buildings is expected to involve more active façade technologies, acting in intelligent collaboration with the HVAC and lighting systems to produce comfortable indoor environments with reduced energy consumption. This project addressed several critical challenges: the need for practical control systems that work, the need for durable, low-maintenance and low-cost dynamic façade technologies with controllable properties within a large solar-optical range, and the need for third-party data demonstrating that such systems can work and be acceptable to building occupants.

*Smart Controls: Philips North America, View Dynamic Glass, Glen Raven, Hunter Douglas/Nysan*

This project demonstrated that model predictive controls can satisfy complex and conflicting performance metrics more optimally than conventional if-then heuristic controls and with increased integration with other building systems. A framework was developed that can be widely deployed in the industry and tailored to individual building applications with low technical expertise and at relatively low cost. The framework produces lookup tables generated using models, optimization algorithms, and supercomputing resources (e.g., Amazon) within a few days. The lookup tables are downloaded to a low-cost embedded controller and used to actuate the dynamic façade. Field tests in the LBNL Advanced Windows Testbed of a two-zone exterior blind (Hunter Douglas/Nysan) demonstrated controls that minimize lighting and



HVAC energy use. The system resulted in an 18 percent reduction in total energy use compared to the conventional controls that constitute the majority of automated shading products offered on the market today.

The power of model predictive controls is transformative and has been demonstrated successfully on complex problems in the aerospace and transportation industries (e.g., self-driving cars). Model predictive controls are making their way into building controls, primarily for HVAC components in the United States, although there are front runners like Philips North America who are developing model predictive controls for use with shading and lighting control systems. LBNL is developing an open-source Buildings library in Modelica to broaden use of model predictive controls-based controllers for the whole industry. In the European Union, where model predictive controls have gained significant traction for building and urban systems control, many of the Modelica models have been developed by manufacturers and are proprietary. Dynamic fenestration systems can contribute to reaching the long-term strategic goals of zero net energy use in California through integration and optimization with other building systems.

#### *Thermochromics: Pleotint and near-infrared switching devices*

A detailed investigation was conducted to determine the technical potential of a polymer-based, thermochromic window (Pleotint, Inc.) for commercial building applications. The film can is designed to be used as an interlayer in a laminate configuration within a low-emissivity insulating glass unit. These materials passively control solar heat gains in buildings and can be a low-cost alternative to electrochromic windows.

Measurement methods were developed to determine the solar-optical properties of the switchable device using conventional equipment. Simulation tools were also developed to model the temperature-based switching effect in Optics, WINDOW, and EnergyPlus.

Annual energy savings of a prototypical large commercial office building were found to be slightly greater than an advanced low-e dual pane window but less than a triple-pane low-e window in hot/cold and hot climates. In field tests, the Pleotint window maintained a transparent, undistorted view across its switching range and had no discernible difference in tinting as viewed from the indoors or outdoors when there was localized shading on a portion of the window.

Hypothetical near-infrared switching thermochromics were modeled, findthat that in near-infrared thermochromic yielded modest reductions of 3-17 percent less annual energy use than commercially available, spectrally selective low-emittance windows in hot/cold and hot climates.

#### *Near-infrared switching electrochromics: Heliotrope Technologies*

Similar to the near-infrared thermochromics, electrochromic devices that exhibit switching in the near infrared could maintain daylight in indoor spaces while controlling solar gains. Such devices would also exhibit minimal changes in color, which could meet the aesthetic requirements of architects and homeowners who desire a clear, transparent façade.

A study conducted by the Molecular Foundry at LBNL (funded separately) found that the electrochromic with the broadest switching range and lowest minimum solar heat gain coefficient resulted in lowest energy use for both residential and nonresidential buildings. Annual HVAC energy savings were significant across all climates for residential applications and in northern climates for commercial applications.. The material science R&D effort resulted in a demonstration of the feasibility of near-infrared-selective plasmonic electrochromic coatings. Heliotrope Technologies, Inc., in California was founded based on the research and is currently working to bring the initial prototypes to the market.

*Monitored demonstration: MechoSystems, Lutron Electronics*

The U.S. DOE funded a post-occupancy monitored evaluation of The New York Times Building in 2012 with cost-share from the PIER program for modeling tools that would also be useful for California-based projects. The Times portion of the 52-story, 1.5 million square foot high-rise building uses automated roller shades, dimmable lighting, and an underfloor-air distribution system, the former two of which were developed specifically for the building using the latest technological advances at the time. The year-long evaluation was conducted five years after the building was occupied to determine actual energy savings and end-user response resulting from these systems. This study provided critical user acceptance, satisfaction, and comfort data that are applicable to all climates.

Measured results in the final building showed a 24 percent reduction in annual electricity use and 51 percent reduction in heating energy use, compared to expectations from a design that just met the prescriptive energy-efficiency code in effect at the time of construction. It also showed a 25 percent reduction in peak electric demand. In addition, a significant fraction of occupants indicated a high level of satisfaction with the overall building and its design features. The Times Company's investment in advanced energy-efficiency technologies is estimated to yield a 12 percent rate of return on their initial investment.

Results evaluating occupant satisfaction with the shades' operation were mixed. The post-occupancy evaluation included issuance of a survey to which a large number of the occupants (665 people) responded. While manual override of the automatic shading system occurred infrequently for the majority of the motors (80 percent overridden an average of 18 times per year), the remaining 20 percent of the occupants overrode the shades an average of 29 percent of the year with most actions to lower the shade. Analysis of other survey questions concluded that the overall indoor environmental quality was very satisfactory for the majority of the occupants and contributed to their ability to get their job done.

*Monitored demonstration: Sage Electrochromics*

In 2010, the U.S. DOE's Emerging Technologies Program supported a pilot demonstration of Sage Electrochromic windows in a conference room in Washington DC in order to experience firsthand how the technology performed in their day-to-day working environment. The technology is an emerging product: the window was automatically switched from a clear to tinted transparent state to control solar gains, daylight, and glare. Monitored weekday lighting energy use savings were 91 percent compared to the existing lighting condition

(scheduled lighting controls). Total annual energy savings were estimated to be 39–48 percent compared to the existing window and lighting condition, which met the ASHRAE 90.1-2007 level standards, except for the higher window U-value. Summer electric peak demand was reduced by 22–35 percent.

A more extensive demonstration of Sage Electrochromics was under way at the conclusion of this project through the General Services Administration's Green Proving Ground Program. Electrochromic windows will be and monitored for about a year to evaluate energy performance and occupant comfort and response in a conventional federal office building in Sacramento, California. This study is scheduled to commence in late spring of 2014.

#### *Automated exterior shading demonstration: WAREMA*

The University of California at San Diego (UCSD) invited LBNL to provide design assistance on their new Health Sciences Biomedical Research Facility II at the early stages of programmatic planning in 2008. From the very start, fixed and automated exterior shading were being considered by the design team to meet energy-efficiency and comfort goals. Enhancing the quality of the interior environment was also one of the core goals. Modeling tools were needed to determine the life-cycle cost benefit of the technology and avoided carbon dioxide (CO<sub>2</sub>) emissions, which was a key metric that UCSD used to evaluate progress toward their campus goal of achieving zero net energy use and sustainability. Zimmer Gunsul Frasca Architects relied on EnergyPlus and COMFEN to work out how the blind should be best configured (e.g., indoor blinds for upper window, outdoor blinds for lower window). Later, UCSD was introduced to the concept of model predictive controls. The campus engineer then allowed LBNL to develop a detailed case study to determine the potential benefits and drawbacks of this alternate mode of control. Visualization of the various modes of control over the range of environmental conditions provided the owner with some level of comfort on what to expect from this optimized control. UCSD voiced interest in implementing the control system in the future after occupancy.

#### **Project Benefits**

The objective of this work was to support industry's development and deployment of both incremental and breakthrough façade technologies in partnership with the U.S. DOE. The project directly supported the R&D efforts of individual industry partners but also developed core measurement and modeling capabilities that will benefit the entire fenestration industry for years to come.

The innovative technologies that industry is developing today largely accommodates the complex performance trade-offs between solar control, daylight admission, mitigation of glare, and access to view that is needed to achieve significant reductions in energy use and peak electric demand compared to conventional systems. The virtual prototyping tools developed in this project could help to accelerate industry's ability to fine tune these technologies, spurring further growth in innovation. The game-changing model predictive controls industry was applied to the science of crafting control logic for integrated systems. This innovative approach will enable the dynamic façades industry to more rapidly develop robust and integrated

controllers in the face of an ever-growing complicated building and urban context that includes energy use, cost minimization with on-site generation, peak generation costs, comfort, indoor environmental quality, and other considerations.

The daylighting technologies targeted lighting energy use in both the perimeter and core zone of buildings, 30–40 feet from the window, while angular-selective shading and dynamic façade technologies targeted HVAC and lighting energy use in a typical 15 ft deep perimeter zone. In combination, the technologies investigated in this study are estimated to be capable of reducing statewide energy use by 201 gigawatt-hours and peak electricity demand by 34 megawatts<sup>1</sup> with a commensurate reduction in carbon dioxide, sulfur dioxide, and nitrogen oxide emissions of 112,000 metric tons, 82 metric tons, and 95 metric tons, respectively.

California is strategically positioned to provide a leadership role in supporting innovative technologies. The technologies investigated in this study, many of which were developed or deployed in partnership with California-based companies, can help California reach its long-term strategic goals of zero net energy use in the next decade.

---

<sup>1</sup> This estimate is based on California commercial building energy use by building type and floor area (Itron 2006), assuming a 2 percent market penetration and 15 percent reduction in annual energy use and peak demand.



# CHAPTER 1: Introduction

## 1.1 Background and Approach

### 1.1.1 Project Context

Growth in California energy use consumption per capita has remained roughly flat since 1980 while the rate in national consumption has increased significantly over the past three decades with business-as-usual practices. California leads the nation in building energy efficiency; its “building and appliance standards have saved consumers more than \$56 billion in electricity and natural gas costs since 1978 and averted building 15 large power plants” (California Energy Commission 2007). To this day, California continues to lead by passing policies and legislation that support strategic initiatives designed to curtail growth in statewide energy consumption, improve statewide competitiveness in the face of rapidly escalating fuel prices, and meet aggressive greenhouse gas (GHG) emission-reduction goals.

In September 2008, the California Public Utilities Commission (CPUC) adopted the California *Long-Term Energy Efficiency Strategic Plan* (CPUC 2008) with support from the Governor’s Office, the California Energy Commission (Energy Commission), the California Air Resource Board, the state’s utilities, local government, and other key stakeholders. The plan defined big, bold initiatives to meet aggressive energy-efficiency and greenhouse gas reduction goals for the residential and commercial building sectors.<sup>2</sup> To achieve these goals, the plan adhered to the state’s loading order, which identifies energy efficiency as California’s top priority resource.

The plan identified the development and deployment of energy-efficiency technologies as fundamental to California’s vision and goals and emphasized that given the short time frame to reach these goals, a targeted focus was needed to move innovative technologies more quickly into the marketplace. This targeted focus requires some historical context to understand how the state’s focus in technology research and development (R&D) was changed. The Energy Commission’s Public Interest Energy Research (PIER) program has historically funded technology development in its late applied stages, and the Emerging Technologies Coordinating Council (ETCC) then played the final role of moving market-ready but not commonly accepted technologies from the late test phase to general use. With the new plan, the utility and Energy Commission support was refocused to create “demand pull and set the research agenda for both incremental and game-changing energy-efficiency technology innovations.” Targeted emerging technologies R&D were to support the big, bold energy-efficiency strategies and integrated energy-solution goals to achieve profound improvements in the building materials and designs necessary to achieve zero net energy goals.

---

<sup>2</sup> All new residential construction will be zero net energy by 2020. All new commercial construction will be zero net energy by 2030. These goals were based on the Architecture 2030 Challenge to have all new buildings and major renovations reduce their carbon emissions by 50 percent by 2010 and then to increase new buildings’ performance to be carbon neutral by 2030.



Federal R&D funding and private industry investments in technology development were critical to realizing plan goals. In February 2009, the American Recovery and Reinvestment Act of 2009 was signed into law by President Barack Obama, providing an unprecedented \$787 billion as a stimulus package in response to the global recession. The Act provided \$40 billion from the Senate and \$28.4 billion from the House for energy-efficiency and renewable energy programs to spur technological advances in science, among other objectives (ARRA 2009). The U.S. Department of Energy's (DOE) Office of Energy Efficiency and Renewable Energy (EERE) was awarded \$16.8 billion for its programs and initiatives. Of those funds, \$22.8 million was allocated in June 2010 to support private industry R&D of window and envelope technologies over the following three to five years (EERE 2010). In 2009, breakthrough R&D was funded through a newly established DOE program—the Advanced Research Projects Agency (ARPA-E)—to maintain U.S. competitiveness by funding potentially transformational energy technology projects. With funding allocated to private industry, national laboratories were encouraged to offer core support to private industry for characterizing, testing, and enabling accelerated adoption of new technologies into the market.

Within this evolving context, the High Performance Building Façade Solutions–Phase II project was initiated through the PIER program in July 2010, to support industry's development and deployment of both incremental and breakthrough façade technologies in partnership with DOE. Since window heat gains and lighting energy contribute significantly to both annual energy use intensity and summer peak electric demand in the temperate, sunny climates of California (particularly in inland areas where there has been significant population growth) the project focused on low-cost retrofit technologies such as daylighting and shading attachments. Its goal was to achieve near-term, broad market impact, as advocated by California Assembly Bill 758<sup>3</sup> (Brook et al. 2012). To address the Energy Commission's zero net energy goals defined by the *California Long Term Strategic Energy Efficiency Plan*, the project also investigated potentially game changing, dynamic, controllable façade systems, which have the ability to respond actively to real-time changes in weather, occupant requirements, and energy demand in concert with controllable lighting and heating, ventilation, and air-conditioning (HVAC) systems. In both development efforts, the project team took an integrated approach to the development of innovative façade technologies. This approach is explicitly advocated by the Energy Commission considering façades influence and therefore enable reductions in both lighting and HVAC energy use and impact occupant preference, satisfaction, and comfort—as well as indoor environmental quality (as related to mood, health, productivity)—in profound ways.

### 1.1.2 Technical Objectives

The project team intended the work to meet the SB 1250 goal, per Section 25620.1(b) of the Public Resources Code, by providing for increased energy efficiency in buildings beyond applicable standards and to the benefit of electric utility customers.

---

<sup>3</sup> AB 758, Skinner, Chapter 470, Statutes of 2009.

The objective of this work was to develop, or support development and deployment of, promising near-term and emerging zero net energy building façade technologies for solar control and daylighting, addressing two of the largest end uses in California commercial buildings: cooling and lighting. Specific performance objectives were to:

- achieve reductions in energy use and peak demand at the perimeter zone at levels of 15–20 percent below Title 24 2008 requirements with mainstream technologies
- achieve reductions in energy use and peak demand at the perimeter zone at levels of 20–30 percent below Title 24 2008 requirements with emerging technologies
- maintain or improve occupant comfort and amenity.

Market-related objectives were to broaden end-user awareness of the performance benefits associated with emerging fenestration technologies in order to increase market adoption of new energy-efficiency technologies. Third-party data from simulations, field tests, and demonstrations reduce information barriers and serve to define the overall value proposition associated with an energy-efficiency upgrade. Project activities focused on providing such data to stakeholders and decisionmakers and on developing user-friendly tools to facilitate end-user assessments of innovative technologies for specific projects.

### 1.1.3 Approach

The technical approach to developing or supporting the development of emerging technologies in collaboration with private industry relied on an array of tools to measure, test, and analyze the performance of prototype technologies, depending on the prototype's stage of development. As the California and U.S. center of excellence in the area of window and daylighting systems, LBNL has state-of-the-art laboratories and modeling capabilities that enable evaluation of unique materials, components, and systems.

Having an explicit path to commercialization was a prerequisite for technology R&D. Partnerships with industry included:

- 3M,
- Dow Chemical,
- Glen Raven Custom Fabrics,
- Hunter Douglas/ Nysan/ Embedia Technologies,
- LightLouver,
- Lutron Electronics,
- Mechosystems,
- Microshade/ Photosolar,
- Panelite,

- Philips North America,
- Pleotint,
- Sage Electrochromics,
- Saint-Gobain North America,
- Schott North America,
- View Dynamic Glass,
- Viracon, and
- Wausau Window and Wall Systems.

Partners provided in-kind funding through prototype development, provision of product for laboratory and field testing, and access to technical and market expertise as related to prototype development and demonstration activities.

In this project, two additional, unique capabilities were developed to support industry:

- (1) the capability to measure, characterize, and model the energy and comfort-related impacts of light-scattering, optically complex fenestration systems (CFS) using measured bidirectional transmittance and reflectance data coupled with simulation tools
- (2) the ability to rapidly develop new shading and daylighting systems using modeling tools run on supercomputers.

Both capabilities were used to support LBNL and private industry's development of new technologies, as described in the following chapters.

The project team conducted full-scale outdoor field tests in the LBNL Advanced Windows Testbed facility and demonstrations in occupied buildings of commercially-available emerging technologies and new prototype technologies in the late applied stages of development. These tests were conducted to evaluate performance claims and potential implementation, commissioning, maintenance and operations issues.

To facilitate decisionmaking and specification of emerging fenestration technologies by the end-user community (e.g., architects and engineers for new construction; owners and general contractors for retrofit construction), the team developed a tool (COMFEN) that provides a user-friendly interface to the EnergyPlus energy simulation software and incorporates many of the latest modeling capabilities for the prototype technologies. The team also collaborated with industry to develop a standard rating procedure for shading and daylighting attachments that could be incorporated in energy-efficiency codes and standards.

## **1.2 Benefits to California**

Developing innovative, cost-effective energy-efficiency technologies and bringing them to the market for use by California consumers is a core objective of the Energy Commission program. In the near term, retrofit shading and daylighting technologies will provide consumers with practical solutions to significantly reduce energy use and peak electric demand and improve comfort, helping the State to continue to flatten or even decrease per capita energy consumption and postpone the need for future generation capacity as renewable energy technologies become more widely adopted. In the long term, the unique tools and prototype technologies developed in this project are expected to result in very low-energy buildings that are more flexible to the variable demands on the utility grid, moving us closer to the goal of zero net energy use and reduced greenhouse gas emissions.

## **1.3 Report Organization**

This report is organized around technology research and development activities related to daylighting technologies (Chapter 2), solar control technologies (Chapter 3), and dynamic fenestration technologies (Chapter 4). Each of these chapters first describes the tools and capabilities that were built to enable characterization and modeling of the technologies, then describes the various prototype technologies that were developed in partnership with industry to address the performance objectives of this project. If the technology was sufficiently mature, results from full-scale field tests and demonstrations in real buildings were included in these chapters. Market transfer and outreach activities are described in Chapter 5.

# CHAPTER 2: Daylighting Technologies

## 2.1 Introduction

Electric lighting is one of the most significant energy end uses in California commercial buildings, constituting 19,265 gigawatt-hours (GWh) or 29 percent of the total 67,077 GWh of total site commercial electric consumption per year (Itron 2006). While the industry has invested over a hundred million research dollars to derive cost-effective, energy-efficient solid-state lighting with a targeted performance of 130 lumens per watt by 2025 and a color rendering index that closely reproduces the visible portion of the solar spectrum (DOE 2012), natural daylight at a photopic luminous efficacy of 683 lumens per watt can still play a niche but key role in achieving very low or zero net energy (ZNE) buildings. Sidelighting and toplighting using conventional windows and skylights has only affected at most a small portion of the perimeter zone floor area, since daylight rarely penetrates beyond one to two times the height of the window wall (about 4.6 meters [m], 15 feet [ft]) in conventional office buildings) when interior shades are used to control direct sun and glare from the window. Electric light sources such as the fluorescent or light-emitting diode (LED) lamps are required to light the remaining area of the building interior. With the increasingly stringent energy-efficiency standards, lighting designers are forced to use electric lighting more judiciously (e.g., lowered ambient lighting levels from 500 lux to 300 lux).

With advancements in technology, daylight can be extended deeper into the perimeter zone and provide supplemental temporal lighting in the core zone of buildings. In California, where clear sky conditions predominate and the cost of electricity is high, the technical and market potential of these technologies are more promising than other areas of the United States. Daylighting technologies can not only improve the overall energy efficiency of the building but also improve the indoor environmental quality of buildings. They accomplish this by increasing overall brightness throughout the room cavity and providing a connection to the outdoors (if not through direct views out the system then through variability in daylight levels as clouds pass over the sun, etc.). Since daylighting is not forced to an upper limit, light levels are often ten times that provided by electric lighting (even within the bounds of glare control). Spectrally selective low-emissivity (low-e) windows provide architects and engineers with the option to now specify high visible transmittance windows without the penalty of increased cooling energy use.

Sunlight-redirecting systems are one of the many ways that daylight can be extended deeper into sidelit perimeter zones. In an overview of daylighting systems (Ruck et al. 2000), the International Energy Agency Task 21 participants compiled a list of emerging daylighting technologies that improve daylighting performance through the various principles of optics: refraction, diffraction, reflection, and any number of combinations of these modes of lighting. None of these systems were evaluated on an annual basis, unfortunately, because the simulation tools needed to model such systems were unavailable. Instead, full-scale field tests were conducted, illustrating performance of various technologies for solstice and equinox

periods and under clear and overcast sky conditions in various climates around the world. Similarly, in Phase I of this project, indoor and outdoor shading systems, some of which were designed to address daylighting, were evaluated using full-scale field tests in Berkeley, California (Lee et al. 2009).

The objective of this second research phase was to develop, or support development and deployment of, promising near-term and emerging daylighting technologies for commercial buildings. Specific technical objectives were to identify technologies and strategies that enable a reduction in annual energy and peak electric demand at the perimeter zone of 20–30 percent below Title 24 2008 requirements while maintaining or improving occupant comfort and amenity. Specific market objectives were to increase the number of products available to consumers that enable optimized performance at commodity-level costs.

This work was accomplished by (1) developing the critical software tools needed to enable industry to rapidly develop and evaluate prototype façade technologies that accommodate realistic performance issues, and (2) collaborating with industry to apply these tools and other methods to evaluate current designs and where possible, incrementally improve innovative technologies based on modeled or measured performance feedback.

This chapter describes the modeling capabilities that were developed that now enable industry to model the energy performance, visual comfort, and indoor environmental quality impacts of optically complex daylighting systems using the Radiance visualization tool. These capabilities were applied first to benchmark the performance of the commercially available LightLouver passive optical light shelf system that can be used for both new and retrofit construction. They were then used to identify the maximum technical potential of an advanced dynamic prismatic metamaterial, and to support the assessment and improvement of a microprismatic daylighting film in collaboration with 3M and in consultation to Dow Chemical. Field tests and demonstration projects were used to confirm the findings of the simulation studies.

In terms of market pull activities, the Title 24 2013 standard mandates the use of switching or dimmable daylighting controls in perimeter zones to a depth of one times the head height of the window. With the development of more accurate modeling capabilities and their incorporation into third-party software, such as Daysim and OpenStudio, the fundamental tools now exist to advocate for extension of the daylight zone deeper into the core in the next code revision cycle. In summary, activities within this task provide a solid foundation for enabling the development and market adoption of innovative daylighting products.

## **2.2 Modeling Optically Complex Fenestration Systems**

### **2.2.1 Overview**

A significant barrier to both developing and promoting daylighting systems is the difficulty in determining the annual energy and visual comfort performance of these innovative systems. Industry adoption of energy-efficient products like sunlight-redirecting mirrored louvers, holographic optical elements, and even conventional roller shades depends on the ability of designers and engineers to quantify and compare the potential benefits of these technologies so

that building owners and stakeholders can make informed decisions. Simulation tools are the most commonly used method to evaluate the performance of daylighting products.

Most commercially available systems, however, are what are called “optically complex” in that incident light is not transmitted specularly (in the same direction as the incident light) like transparent glass. Light is scattered: transmitting in some directions and reflecting in others, and the pattern of scattering differs as the angle of incident light changes.

At the start of this project, a routine, efficient simulation method was urgently needed to accurately model optically complex fenestration systems such as sunlight-redirecting mirrored louvers, holographic optical elements, and even conventional roller shades. These systems were modeled using either Lambertian (hemispherically diffusing) properties or simplified approximations to emulate the properties of these materials, with minimal reliance on measured data. There were no established methods for measuring the properties of these systems or materials and therefore no standardized database like the International Glazing Database (IGDB for specular glass) from which end users could draw product-specific data. There were also no efficient modeling tools available to industry to evaluate the building energy-efficiency or comfort impacts of these products. Simulations based on ray-tracing typically take a day or more of computation time for a single point in time so an annual simulation is impractical for conventional practice.

By the conclusion of this project, LBNL had established protocols for measuring and characterizing the light-scattering properties of these systems and had developed, debugged, and validated the time-efficient simulation tools needed to evaluate the annual daylighting and window heat gain (and therefore, total energy use) impacts of CFS. This section describes the capabilities that were built to evaluate the daylighting performance of optically complex fenestration systems. Chapter 3 addresses the additional work that was conducted to evaluate window heat gains and their impact on HVAC energy use.

### *2.2.1.1 Background*

In 1994, (Klems 1994a) defined a method to quantify solar gains through windows with nonspecular shading and daylighting devices that bridged the gap between expensive solar calorimeter measurements and first-principles analytical models. The method required bidirectional optical measurements of non-specular layers such as shades or blinds, use of optical data for specular glass layers, and matrix layer calculations to combine these individual layer properties to produce overall window system transmittances and layer absorptances from which solar gains can be computed as a function of incident direction. This method was also applicable to assessments of daylighting performance.

Bidirectional scattering distribution function (BSDF) data for nonspecular devices are critical for routine implementation of this method, and obtaining such data has been and continues to be a non-trivial task. A detailed review of the methods used to characterize nonspecular materials is given by (Andersen and deBoer 2006): starting with the first scanning goniophotometer built in 1988 and validation of the calculation method (Klems and Warner 1997) to heterogeneous

methods encompassing measurement and simulation techniques (Jonsson et al. 2009, Andersen et al. 2009).

Klems showed that with a few simplifying assumptions it was possible to derive the overall system transmittance matrix of a set of layers, including all the effects of multiple interreflections between layers, from the optical properties of individual layers (Klems 1994b).

With these approximations, the solar optical properties of a system can be defined in terms of its bidirectional transmittance and reflectance distribution functions (Nicodemus 1965), which are in effect a set of hemispherical luminous coefficients defined by paired incident and outgoing angles. The incoming and outgoing hemispheres are subdivided into a grid of elements (referred to as a “basis”) and the radiance is averaged over each solid angle element or “patch.” To obtain total transmitted radiation for a given incident angle,  $\theta_1, \phi_1$ , the luminous coefficients are multiplied by the incident irradiance and summed for all patches of the hemispherical basis using a matrix calculation, as in Equations 1-2,

$$\tau(\theta_1, \phi_1) = \int_0^{2\pi} \int_0^{\pi/2} BTDF(\theta_1, \phi_1, \theta_2, \phi_2) \cos \theta_2 \sin \theta_2 d\theta_2 d\phi_2 \quad (1)$$

or,

$$\tau(\theta_1, \phi_1) = \sum_{k=1}^{145} BTDF(patch_k) \int_0^{2\pi} d\phi_2 \int_0^{\pi/2} \cos \theta_2 \sin \theta_2 d\theta_2 \quad (2)$$

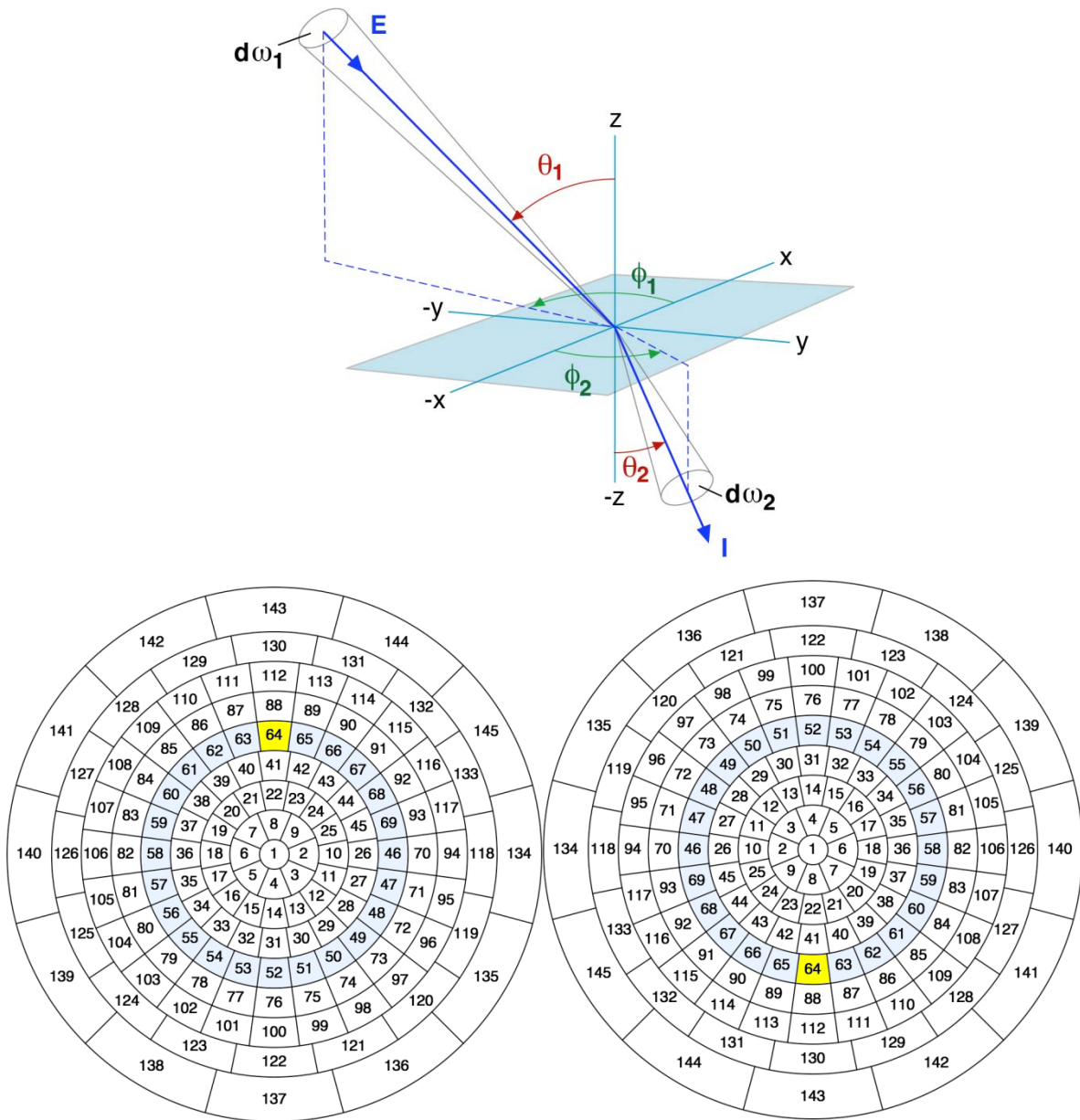
where,  $\theta$  and  $\phi$  (Figure 1) define the boundaries of each patch of the basis and (2) shows integration of flux over the Klems full 145 x 145 basis. The Klems basis is the default basis used in WINDOW 6 (Mitchell et al. 2008).<sup>4</sup>

---

<sup>4</sup> Klems modified the Tregenza hemispherical subdivision to give higher resolution in incident angle and a weighting of the patches proportional to their solid angle and projected area. The angular resolution of this basis is approximately  $\pm 5^\circ$  in incident angle and much coarser in azimuth.



Figure 1: Coordinate system for bidirectional measurements and Klems angle basis



Incident hemisphere discretization (lower left) and outgoing hemisphere discretization (lower right). The angle basis is defined in a way that directly transmitted or specularly reflected light is in the same numbered bin as the incident light (e.g., bin number 64). A ring of Klems bins with the same incident theta angle but different incident phi angle is commonly called a “theta band” (e.g., shaded bins).

Source: LBNL.

For multi-layer calculations, output flux can be used as input for the next layer, enabling one to create a coplanar window system from any arbitrary configuration of individual layers (e.g., glass layer, between-pane shade, glass). Similarly, total reflected radiation for a multilayer

system can be computed. The outgoing total radiation is then distributed to interior room surfaces to calculate solar gains.

### 2.2.1.2 Overall approach

This same method can be applied to daylighting assessments. In this project, the following tasks were performed:

#### Characterization

- Developed the hardware and software needed to measure and characterize the bidirectional solar-optical properties of optically complex systems.
- Examined the effect of increased BSDF resolution on daylight modeling accuracy, then developed the necessary capabilities and tools to enable measurement and use of high-resolution data; i.e., scanning goniophotometer, generation of variable-resolution BSDF datasets using various software tools, debugging and visualization of the BSDF datasets, and a system for archiving the data into a standardized database.

#### Simulation Tools

- Developed, debugged, and validated a point-in-time (*mkillum*) tool and annual simulation tool (three-phase matrix calculation, *rtcontrib*), which uses BSDF data and the methods described above to compute annual illuminance and luminance data for energy and visual comfort performance evaluations. Then, improved the three-phase method by explicitly separating out the direct sun component using a five-phase method, enabling more accurate rendering and illuminance calculations.
- Increased the speed of conducting annual calculations by orders of magnitude using a combination of efficient computational methods and tools that leverage the capabilities of improved hardware (i.e., graphics processing units (gpus), cluster computing).
- Worked with third-party developers of graphical user interfaces to the Radiance tool to incorporate these new modeling capabilities into their software (e.g., DaySim, OpenStudio, COMFEN).

The following sections describe the specific work that was conducted in more detail.

### 2.2.2 Optical Characterization of CFS

As described in the overview, BSDF data are critical for routine implementation of this method. This has proven to be a significant challenge for industry, involving both the technical issues of obtaining, ideally, a continuous measured dataset without relying on data interpolation and the very practical issues of limited time and resources needed to measure every possible permutation of each type of CFS (e.g., color, weave, density, opacity, reflectivity of fabrics). One approach has been to characterize the properties of a class of CFS, measure a representative subset of the systems, then develop mathematical models to fit the light-scattering characteristics of the class so that not every permutation has to be fully measured. Such an approach was used to create models of roller shades and venetian blinds in WINDOW that combine goniophotometric measurements for a limited number of incident angles with a fitting

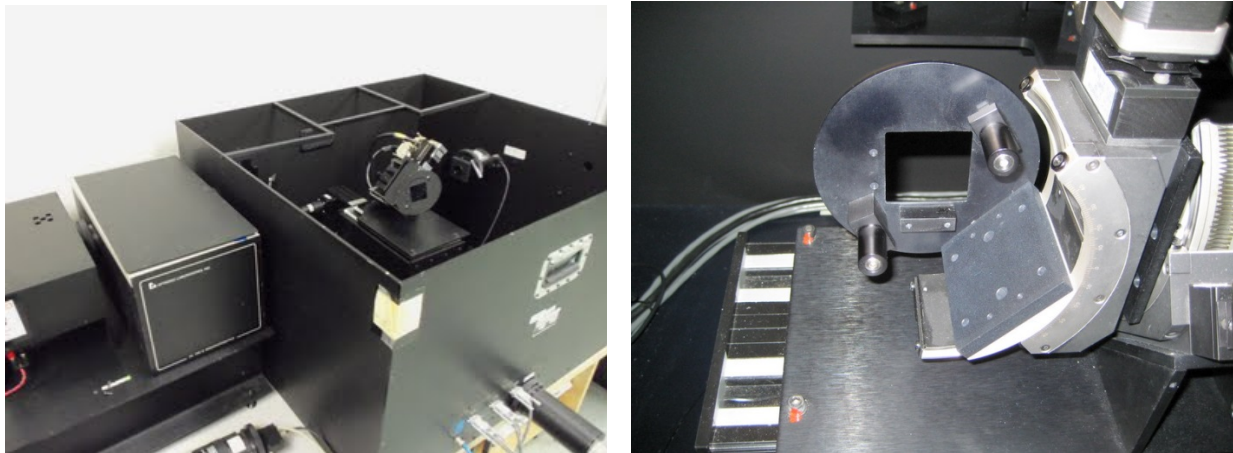
routine; a full BSDF dataset is created based on the behavior from the limited measurements (Andersen et al. 2005; Nilsson and Jonsson 2010; Jonsson et al. 2008).

A second approach is to make detailed BSDF measurements of a small flat sample of the system's base material (e.g., paint chip of a venetian blind slat, Figure 2) and then use commercially available ray-tracing software to generate a complete synthetic BSDF data using the measured data and the geometry of the system (e.g., a curved, 1-inch slat of a venetian blind positioned horizontally). The third most time-consuming approach involves measuring the transmitted and reflected flux for every incident angle. For the Klems basis, this would involve 145 incident angles if the sample was non-symmetrical and take about two to three weeks to measure per sample.

At the beginning of this project, the above approaches were in the initial stages of development (e.g., models for fritted glass [Jonsson et al. 2009]). Over the course of this project, all three approaches were fully developed then incorporated into the WINDOW software tool. End users can now either select a specific product from the complex glazing database (CGDB) or create a product based on various inputs to WINDOW, then create a BSDF extensible markup language (XML) output file for a multi-layer window system consisting of glass, shading, and daylighting layers that can be used in Radiance and EnergyPlus. Models were developed for roller shade fabrics, venetian blinds with curved and flat slats, and insect screens. Some systems for which generalized models were inapplicable were measured fully and included in the database.

Several key capabilities were built to achieve routine measurement and characterization of CFS. The following sections describe the work conducted over the course of this project to build these capabilities.

**Figure 2: Small-scale goniophotometer**



Small-scale goniophotometers are used to measure the bidirectional optical properties of small sample materials (e.g., 1 x 1 inch) that are used in windows or window layers.

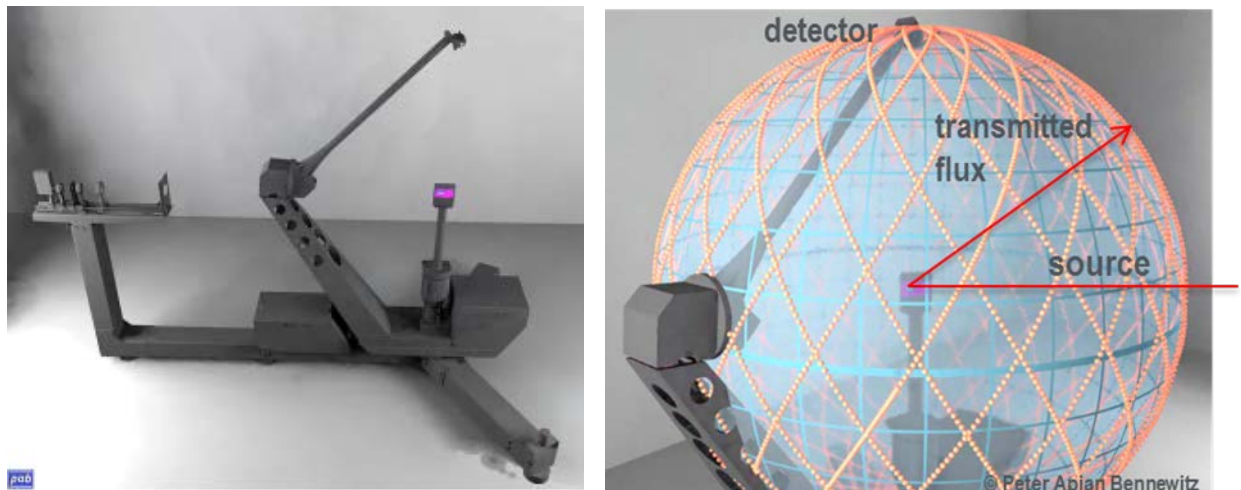
Source: LBNL.

### 2.2.2.1 Measuring full BSDF datasets

#### Scanning goniophotometer

In 2009, LBNL purchased a scanning goniophotometer (Figure 3). The 2.4-m high goniophotometer consists of a robotic arm that moves in a hemispherical pattern around a 25 by 25 cm sample mounted in the center. The sample is illuminated with a 25 millimeter (mm) diameter collimated beam from a halogen tungsten light source, then the transmitted and reflected light scattered off the sample is measured by sensors mounted on the robotic arm. Each sensor is sensitive to specific range of wavelengths, enabling both solar and visible (daylight) characterization of the sample. Millions of measured points are generated for each incident angle. These data are then post processed using Voronoi tessellation to generate a Klems BSDF representation of the data.

**Figure 3: Scanning goniophotometer**



Large-scale goniophotometers are used to measure the bidirectional optical properties of relatively large (e.g., 10 x 10 inch) samples of windows or window layers.

Source: pab advanced technologies Ltd ([www.pab.eu](http://www.pab.eu)) .

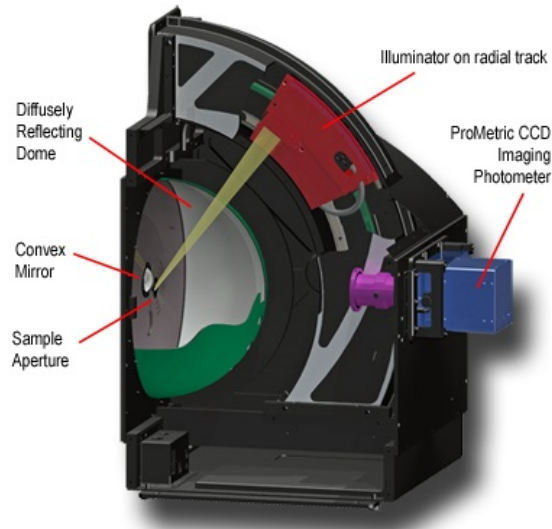
The variation of the incident angle is handled by rotation of the sample holder; however, the original sample holder was only able to rotate the sample in a way that changed the theta angle of incident light. This was suitable for isotropic materials where the behavior was rotationally symmetric and independent of the phi angle. Anisotropic systems (systems without radial symmetry such as a prismatic daylight redirecting film) require measuring many phi angles to fully characterize optical behavior. Without the ability to measure many phi angles automatically within a reasonable time frame (each phi angle adjustment had to be done manually), the limited measured BSDF dataset could not be used for annual simulations. In 2013, the sample holder was upgraded to allow the sample to be rotated about a second axis, enabling automatic adjustment of the phi angle of incident light. Significant work went into defining the protocols for measurement, debugging software, writing new scripts for data reduction, and detecting and troubleshooting causes for data errors. This new capability enables

automatic acquisition of measured data for the full 145 incident angles needed for anisotropic materials within about ten days (Jonsson 2013).

### *Imaging sphere*

Imaging spheres are an alternative device for measuring BSDFs (see Figure 4). Lighting transmitted or reflected by a sample material is projected onto a sphere, then an imaging colorimeter captures the luminance and color of the projected light (Andersen et al. 2010). An imaging sphere allows for simultaneous capture of a full hemisphere of data in a single measurement, without the need for estimation or interpolation. However, known drawbacks of the imaging sphere include reduced dynamic range (dynamic range of the imaging colorimeter is smaller than that of sensors used on a goniophotometer), limited spectral range (visible wavelengths only), and lack of automation (human interaction is needed for every incident angle measurement).

**Figure 4: Schematic of the imaging sphere manufactured by Radiant Zemax**



Source: Radiant Zemax ([www.radiantzemax.com](http://www.radiantzemax.com)).

One industry partner obtained an imaging sphere (Radiance Zemax, model IS-SA) to measure BSDFs of their prototype systems. Data produced by the imaging sphere were not output in the format needed by LBNL simulation software, so the project team developed software that converted the imaging sphere output data to the WINDOW XML file (using the Klems angle basis). Comparisons between the imaging sphere and goniophotometric datasets were made and were found to differ for large angles of incidence. Adjustments to the instrumentation were made to improve measurement accuracy.

#### *2.2.2.2 Generating BSDF data using an open source ray-tracing tool*

In many cases measuring a BSDF is impossible or impractical. For example, a system composed of large-scale geometric components may not fit in the goniophotometer sample holder and/or the goniophotometer beam may not be wide enough to uniformly sample the full pattern of the

geometry. For systems in the conceptual stages of design, there may not be a fabricated prototype to measure, and yet the ability to simulate its performance could inform early stage product design, lowering costs and shortening development time by industry.

To fill these needs, a Radiance sub-program, *genBSDF*, was developed to generate a BSDF file from an input model describing the materials and geometry of a system. There are commercial software packages that can be used to perform a similar calculation, but the software is expensive, limiting access to designers and small businesses, and is designed to address the needs of a wider scientific community. The *genBSDF* tool is for a specific purpose, is open source, and free for download, as are all Radiance tools. The tool uses Monte Carlo ray tracing to compute a BSDF file for a system. Rays intersect with model geometry and evaluate material reflectance functions to spawn new rays. Rays that leave the system are binned by direction and accumulated in angular patches defined by the Klems or other bases.

For systems with large-scale geometry such as a louver system with a unique shape and flat painted surface, *genBSDF* can generate a BSDF of the system using the geometry of the system and the standard material reflectance models available in Radiance. If the material of the system does not fit the standard models (e.g., holographic surface pattern), BSDF measurements of the material can be made using a flat sample of the material. Then the BSDF material data can be used in *genBSDF* to simulate the performance of the system (this capability is made possible by the new Radiance BSDF material described later). The *genBSDF* tool was debugged then validated against synthetic (simulated) and measured datasets (McNeil et al. 2013c).

#### *2.2.2.3 Archiving BSDF data in the Complex Glazing Database (CGDB)*

The complex glazing database (CGDB) is a repository of BSDF data files for optically complex systems and is similar in intent to the International Glazing Database (IGDB), which contains data for U.S. and international commercially available specular glazing systems. Both databases are integrated into LBNL's WINDOW program, which enables users to create a window system comprised of glazing, shading, and daylighting layers and framing components.

The files contain the scattering data describing reflectance and transmittance from both sides of the sample in both the visible and the solar wavelength range. There is no requirement to include geometrical descriptions of the optically complex system; manufacturers may wish to keep this information confidential. When no geometry is provided, CFS in a simulation will appear as a flat surface with optical transmission and reflection properties that match the spatially averaged performance of the system. If geometrical information is included, then the Radiance software can use that information to provide a better visual representation of the CFS and to improve accuracy of spatial effects for direct transmission (i.e., indoor shadow patterns) while the ambient calculation makes extensive use of scattering properties obtained from the BSDF data to accelerate the overall simulation.

The CGDB will continue to be populated with more products as time and resources allow. Between about 2009 and 2013, the National Fenestration Research Council (NFRC) had a working committee that prioritized the shading systems to be measured and characterized by LBNL. In 2013, the committee disbanded and a plan was initiated to develop a new



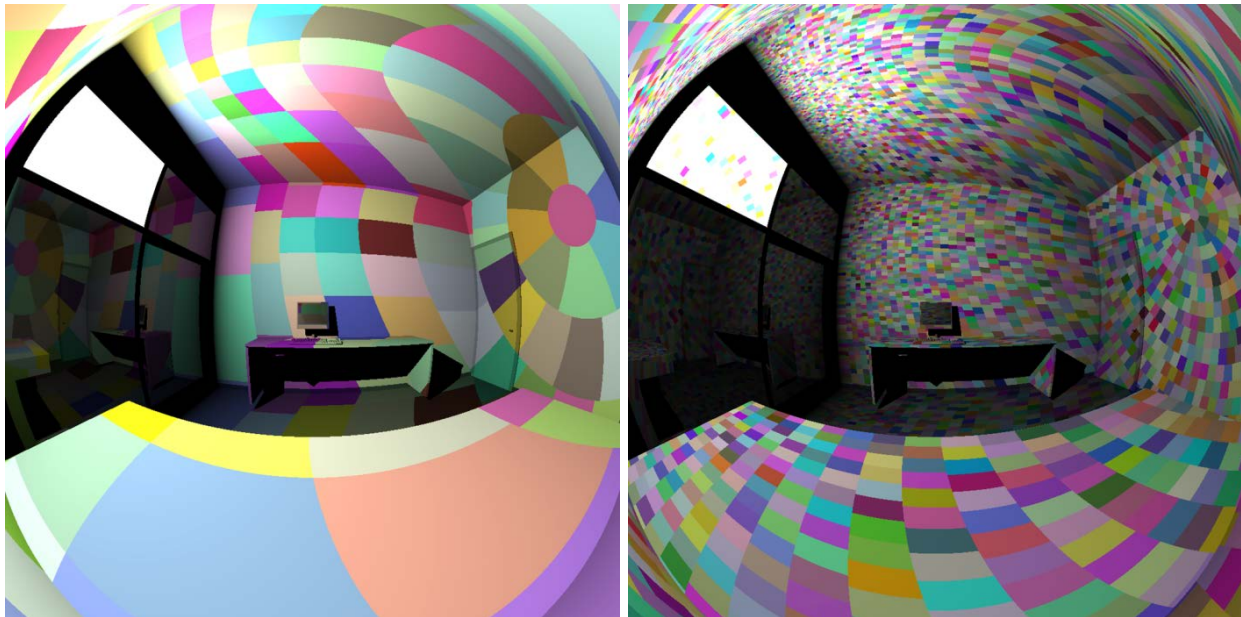
organization to measure and rate shading products primarily for the residential market. This new organization is expected to be created in 2014.

#### 2.2.2.4 Variable-resolution BSDF data

The overview section above described the history of the matrix approach for calculating window heat gains. The size of the matrices used for this calculation was dictated by the initial objective of the calculation: solar heat gains, not daylighting. The  $145 \times 145$  Klems basis is sufficiently accurate for determining solar heat gains. For daylighting, however, higher or even variable-resolution datasets can result in more accurate energy and visual comfort assessments (Figure 5).

A sensitivity study of BSDF resolution demonstrated that the Klems-basis BSDF is sufficient for computing annual illuminance data for a grid of sensor points and for determining lighting energy use (McNeil 2011). The study also demonstrated that the Klems angle basis is not always sufficient for determining glare ratings and annual glare profiles. For some systems, higher resolution BSDF data are required to resolve high-intensity peaks of transmitted light. In simpler terms, the smaller the matrix patch size, the more accurately “peaky” systems such as sunlight-redirecting daylighting systems can be modeled.

**Figure 5:  $145 \times 145$  Klems basis (left) versus  $2^\circ$  basis projection (right)**



Source: LBNL.

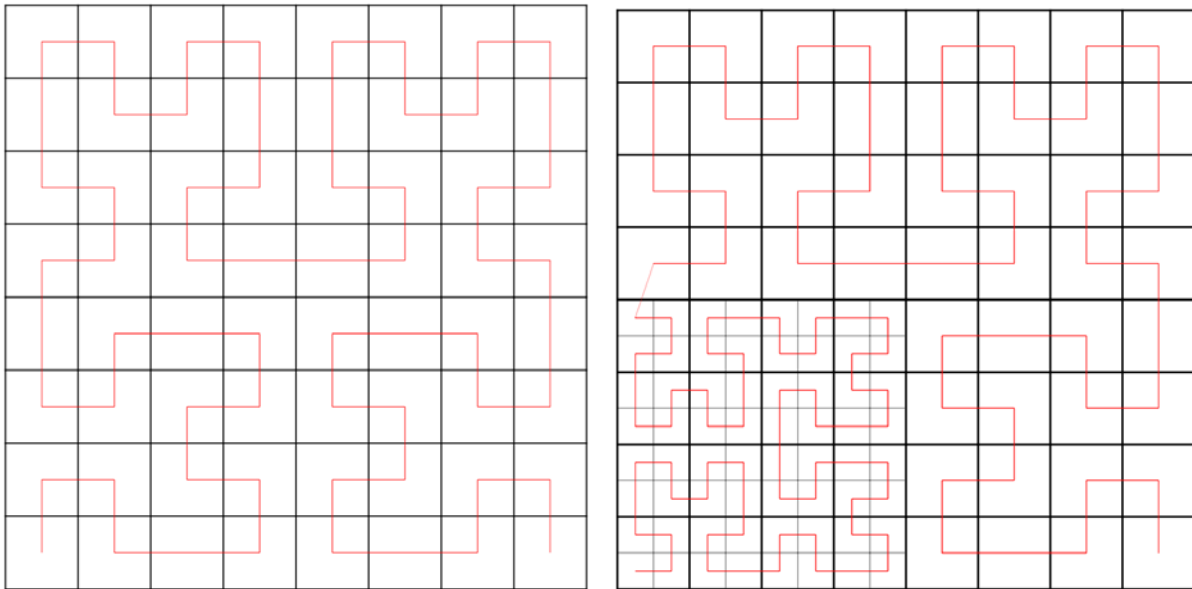
Data requirements for high resolution data can be prohibitive both in simulation and data storage, therefore a new variable-resolution BSDF format, called the *tensor tree* BSDF, was developed that addresses the need for increased data resolution at peaks while using low-resolution data for parts of the BSDF that exhibit more gradual changes (Ward et al. 2012). The tensor tree BSDF uses a hextree structure (i.e., 16 branches per node) to increase resolution in regions of the BSDF where high-resolution data are required. A hextree allows for increased

resolution in some areas of the function without affecting the rest of the distribution. Using a Hilbert space-filling curve orders neighboring patches to provide for stratified Monte Carlo sampling of the distribution (Figure 6).

The square Hilbert curve is mapped to the transmission or reflection hemisphere using the Shirely-Chiu area preserving mapping technique (Figure 7). The variable-resolution tensor tree BSDF format gives the resolution necessary to represent sharp peaks in BSDF functions (Figure 8). The ability to recreate peaks in a BSDF can be critical in assessment of glare for CFS systems.

Radiance tools were developed that enable conversion of measured or synthetic datasets into the tensor tree BSDF format. This provides backwards-compatibility with tools and methods requiring a matrix formulation, and allows any BSDF data source to be used to maximum effect.

**Figure 6: Hilbert space-filling curve**

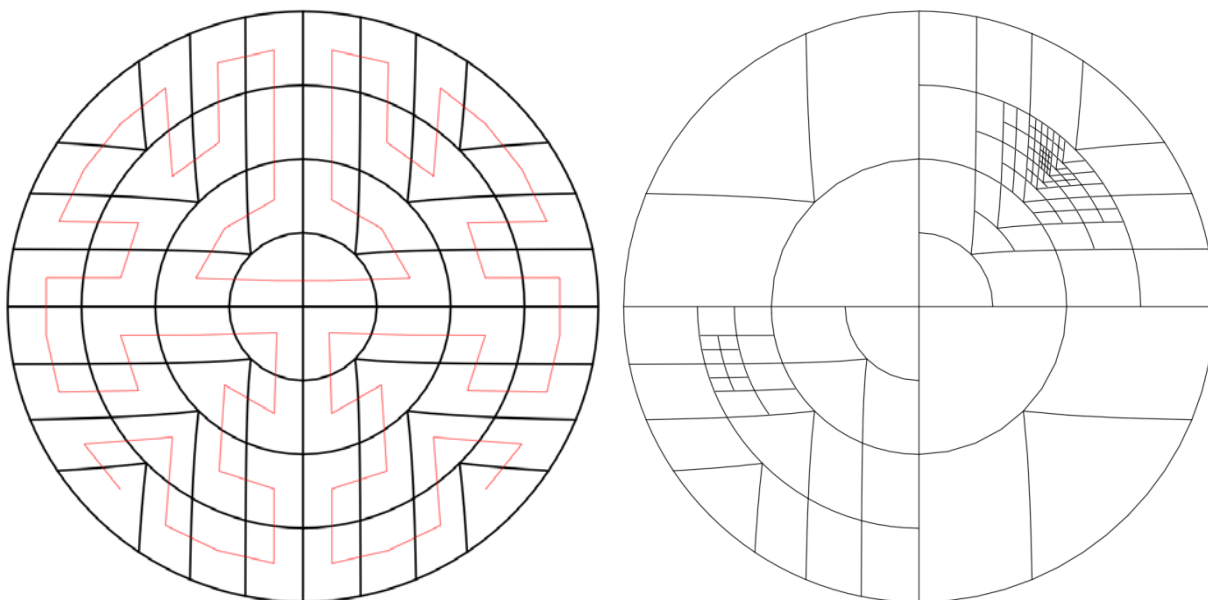


Hilbert curve with constant resolution (left) and a curve with higher resolution in one quadrant (right).

Source: Ward et al. 2012.



**Figure 7: Shirely-Chiu mapping**



A Hilbert curve mapped to a projected hemisphere using Shirely-Chiu mapping (left). An example of a projected hemisphere divided using a variable-resolution Hilbert curve (right).

Source: Ward et al. 2012.

**Figure 8: Images generated using interpolated BSDF datasets**



Comparison between full 145 x 145 Klems BRDF representation (left), reference anisotropic function (center), and 16K x 16K tensor tree representation (right)

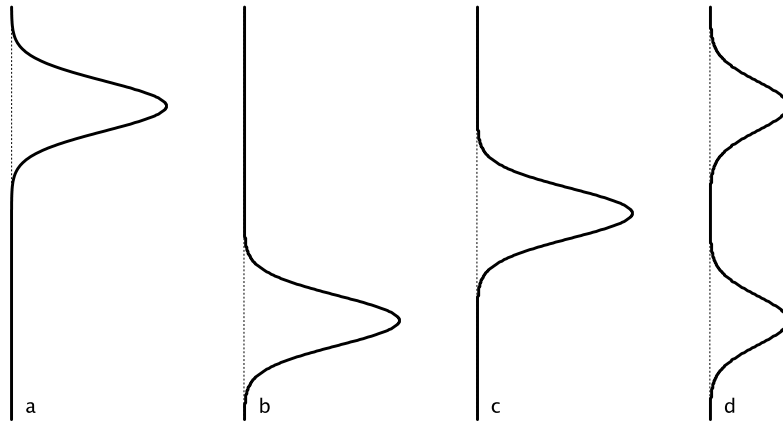
Source: Ward 2013.

#### **2.2.2.5 Full BSDF datasets using interpolated measured data**

Creating a tensor tree BSDF via measurement requires measuring incident angles at full resolution prior to reducing the data down to the variable-resolution format. The maximum resolution is unrestricted, but typically 4096 patches are sampled at full resolution for a good compromise between time and accuracy. Measuring 4096 incident angles is not practical even

with the new sample rotator on the goniophotometer. The solution the research team developed to this high-resolution measurement problem was to measure at lower than full resolution on the incident hemisphere (while still measuring full resolution on the reflection and transmission hemispheres) and interpolate between measured incident angles to generate data for incident angles that were not measured. Linear interpolation is not suitable since the result would often be two half-intensity peaks where a single full intensity peak is desired (see Figure 9).

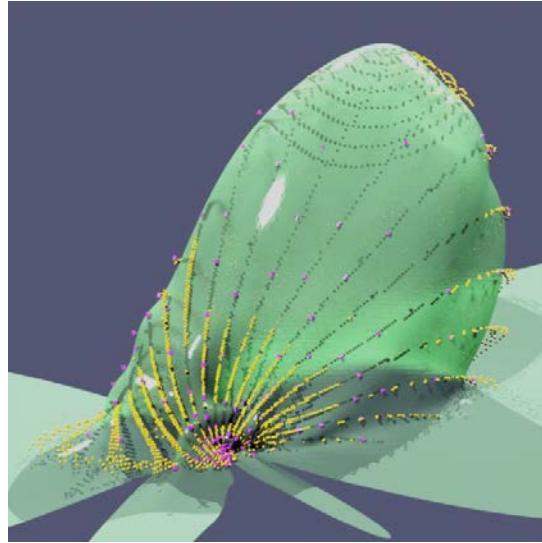
**Figure 9: Illustration depicting the challenge of interpolating between two incident angles**



(a) peak for first incident angle, (b) peak for second incident angle, (c) desired result for interpolation of two incident angles, and (d) linear interpolation of two incident angles a and b.

An application of the earth mover's distance (EMD) algorithm allows for interpolation by moving peaks from one location to another. Prior to running the EMD algorithm, distributions for each incident angle must be represented as a series of Gaussian lobes that comprise the outgoing distribution (see Figure 10).

**Figure 10: Interpolation using Gaussian lobes**



Yellow dots indicate goniophotometric measurements for one angle of incidence. Pink dots are reduced measurements for interpolation. The green sheet is the radial basis function (sum of the Gaussians).

Source: Ward 2013.

A migration coefficient matrix is then created using the EMD algorithm that describes how each lobe migrates and changes from one incident angle to another. Once the Gaussian lobes and migration coefficient matrices are formed, they can be sampled at the full resolution of a tensor tree BSDF (see Figure 11).

**Figure 11: Images generated using three different BSDF representations**



Comparison between reference anisotropic function (left), 16Kx16K tensor tree representation (center), and 16K x 16K tensor tree representation generated by interpolating a sparse subset of incident directions (right).

Source: Ward 2013

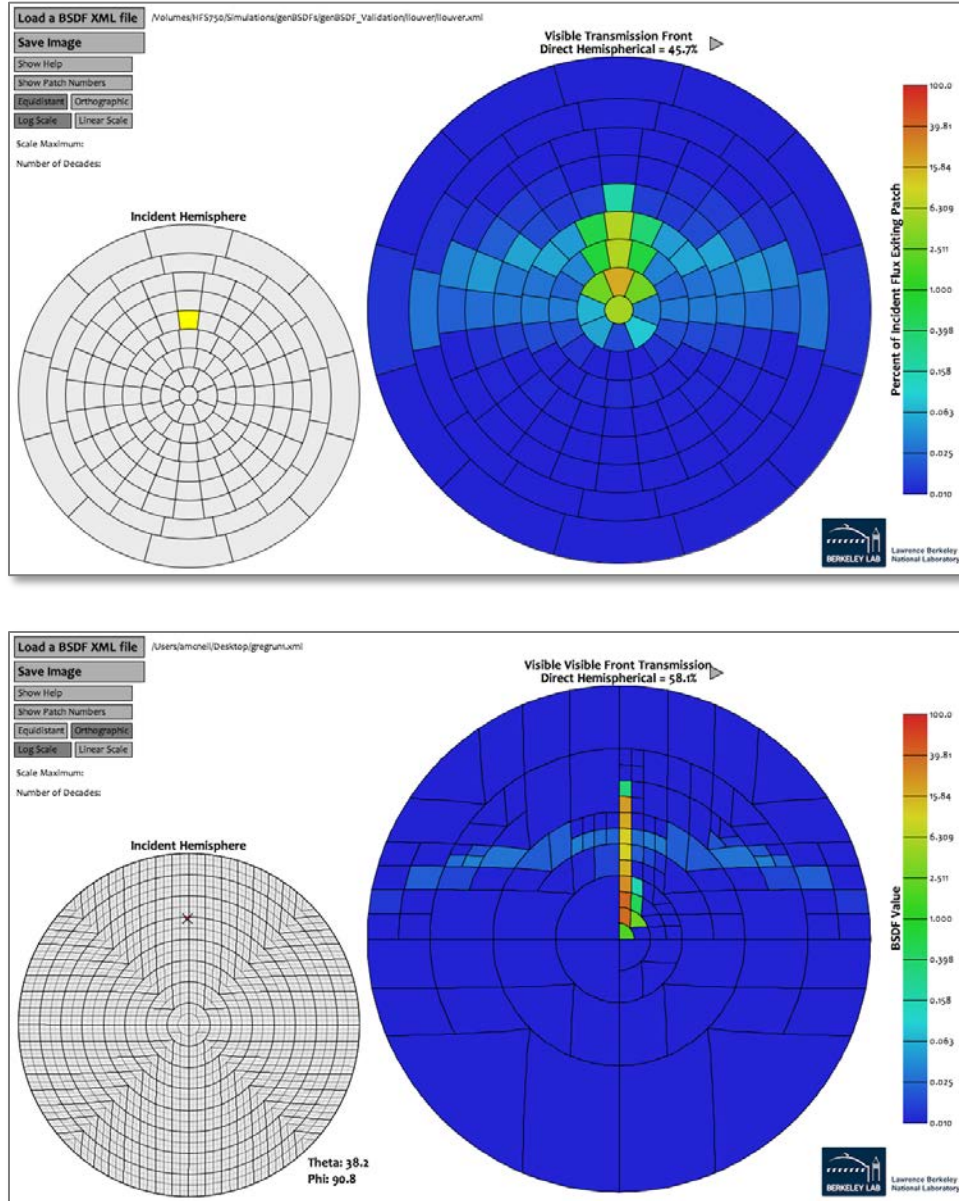
Considerable effort was expended to develop the interpolation tools needed to capture peak distributions with sufficient accuracy. Initial efforts using measured data proved to be tricky since the measured data itself could be erroneous (e.g., a problem with self-shadowing of the goniophotometer was detected during the debugging process). A set of tools and processes were built to debug the interpolation tools based on synthetically generated, high-resolution “measured” data. Data for some incident angles were deliberately omitted, the interpolation tool was used to create the missing data, and then the results were compared to debug the interpolation code. Renderings were also generated to visualize how well an object rendered with the interpolated data matched an object rendered with the “gold standard” synthetic dataset (Ward 2013). In 2014, the work continued with the goal of completion at the end of the year. The challenge of interpolation was one identified over a decade ago (e.g., Erhorn 2004); this work made significant progress toward solving this challenge.

#### *2.2.2.6 Tool for visualizing BSDF datasets*

Measurement and simulation of the light-scattering properties of an optically complex system yields millions of datapoints. As the project progressed, it became apparent that developers needed a tool to plot BSDF data in order to visualize how an optically complex system scattered incident light.

The software program BSDFViewer allows visual representation and inspection of data contained in a BSDF file (McNeil 2013a). BSDFViewer can load a BSDF file containing Klems, horizontally divided Klems (discussed later), or tensor tree format and display the reflection or transmission distribution for the selected incident angle. Users can interactively select a desired incident angle and cycle through reflection and transmission data for front and back surfaces, and the visualized distribution is updated in real time (Figure 12).

Figure 12: Screen shots of BPDFViewer



Screen shots of BPDFViewer displaying BPDF data for a Klems angle basis BPDF (top) and Tensor Tree BPDF (bottom) for the LightLouver system. For the Klems basis, end users click on one of the 145 incident patches on the left, and the visible transmission for 145 outgoing angles is shown in a falsecolor scale on the right. A Klems-basis BPDF .xml file contains  $145 \text{ (incident angles)} \times 145 \text{ (outgoing angles)} \times 4 \text{ (front/back, transmission/reflection)} = 84,100$  values to represent the optical characteristics of an optically complex system. Tensor tree BPDF datasets often contain many more values than the Klems BPDF.

Source: McNeil 2013a.

BSDFViewer has proven to be instrumental in debugging BSDF routines as well as verifying BSDF data. The software was publicly released in 2013 and is available for download from [www.radiance-online.org/download-install/bsdf-viewer](http://www.radiance-online.org/download-install/bsdf-viewer). Outside parties, including 3M, Heschong Mahone Group (HMG), the National Renewable Energy Laboratory (NREL), and Daylighting Innovations, among others, have made extensive use of the BSDFViewer tool for their R&D activities.

## 2.2.3 Computing Daylighting Performance of CFS Using Radiance

### 2.2.3.1 Background

The backwards ray-tracing approach used in Radiance needs to know a priori where to look for light sources and where to find peaks in the BSDF, so that the software knows where to send sample rays for optimal results. The standard approach for CFS in Radiance is to precompute the light passing through each window or skylight, treating it as a “white box” in the final rendering, otherwise known as a “secondary light source.” The original mkillum program was written to convert a CFS, described as geometry and materials, into a secondary light source with a candlepower distribution corresponding to a particular exterior condition (e.g., sun, sky, obstructions, reflections). In this mode, mkillum is computing all the light interactions of whatever CFS might be placed in the opening.

While the standard mkillum technique just described works well most of the time, there are important cases where it fails. Using a backwards ray-tracing approach, it is nearly impossible to account for sunlight transmitting through a system with curved, specular elements. However, if the tool is given the BSDF as input, the input can be applied directly to convert the exterior illumination arriving at the window or skylight into an interior candlepower distribution. A photon-mapping extension (i.e., forward ray-tracing) may also be used for such systems, although it fundamentally changes the way Radiance works (Schregle and Weinold 2004). Neither approach is practical for annual simulation, since a separate precomputation step is required for every solar condition. A daylight coefficient (DC) method is needed.

The Daysim version of Radiance was developed specifically for annual simulation using daylight coefficients (Bourgeois et al. 2008), but it cannot take advantage of mkillum in its calculations. All light passing into the space must be accounted by the single-step backwards ray-tracing approach in Radiance, making venetian blinds and other CFS a serious challenge. Particularly if the CFS is operable, the basic DC approach can become quite expensive.

The project team developed two techniques for incorporating BSDF data in Radiance. The first technique enhances mkillum so it can precompute light output from CFS portals (windows or skylights) using BSDF data, permitting a broader array of systems to be modeled. The mkillum tool is used for point-in-time calculations and renderings. The work done to modify this tool is described in (Ward et al. 2010).

The second technique extends the DC approach using the *rtcontrib* program to compute coefficients for incoming and outgoing directions on CFS with BSDF data connecting the two. This offers advantages for annual simulation and operable shading devices, and changing the

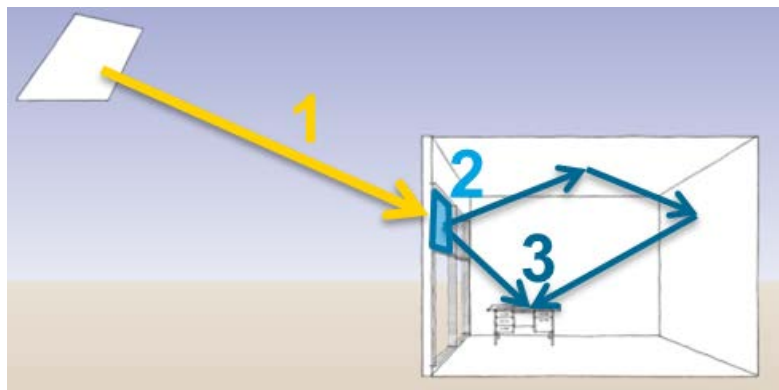


control setting is as simple as swapping matrices in an inner time-step loop. The basics of this calculation method are described below in what is called the “three-phase” method.

### 2.2.3.2 Three-phase method for annual simulation of CFS

The three-phase method implements Equation 3 below by dividing the luminous energy transfer into three stages, from the sky to the exterior of a window, through the window, and from just inside the window to interior sensor points (Figure 13). Energy transfer for each stage is stored in a coefficient matrix. Multiplying the matrices together with sky luminance values generates a simulation result.

**Figure 13: Three-phase method**



Three-phase method consists of: (1) daylight coefficient matrix, (2) transmission or BSDF matrix, and (3) view coefficient matrix.

Source: LBNL.

$$I = VTDs \tag{3}$$

Where

V = View (interior) coefficient matrix

T = Transmission coefficient matrix (BSDF)

D = Daylight (exterior) coefficient matrix

s = Sky vector containing average luminance of each sky patch.

Ray tracing methods are used to create the V and D matrices. The matrix multiplication stage is relatively fast compared to the ray tracing phase. Once V and D matrices are created for a building and site, simulation results for various CFS and sky conditions can be generated quickly. Annual simulations are performed by looping through all hours of the year and changing the sky vector according to weather data. This method also allows simulation of dynamic façades by changing the T matrix from one timestep to the next (e.g., ten T matrices for ten different slat angles on a venetian blind).

The three-phase method was validated against empirical data collected in the LBNL Advanced Windows Testbed (McNeil and Lee 2012). Work plane illuminance data for a daylight-redirecting optical light shelf were measured in a full-scale, unoccupied private office over the course of a year. These data were compared to simulated data generated by the three-phase modeling tool and found to have an absolute mean bias error (MBE) below 13 percent and a root mean square error (RMSE) below 23 percent for all three sky types (overcast, dynamic, and sunny). Prior validation of the DAYSIM tool indicated that a MBE of less than 15 percent and an RMSE of less than 35 percent was sufficient to consider simulation results to be reliable.

### 2.2.3.3 Improving accuracy with the five-phase method

We mentioned above a sensitivity study that was conducted on BSDF resolution and the work conducted to develop measurement techniques and tools to generate variable-resolution BSDF datasets using the tensor tree BSDF format. This work was driven for the most part by the desire to increase the accuracy of discomfort glare evaluations. A second source of inaccuracy is that the direct sun component is modeled by a sky patch(s) in the three-phase method.

The five-phase simulation method addresses inaccuracies in modeling the direct sun component by separating out the direct component and simulating it separately. Combined with the tensor tree variable-resolution BSDF dataset, accuracy in modeling discomfort glare is significantly improved. The approach for the five-phase method is adapted from the standard model for dynamic daylight simulations procedures proposed by (Bourgeois et al. 2008). When performing the five-phase method, the direct sun component is subtracted from the three-phase result (the inter-reflected sun component remains). Then the direct sun component is simulated without ambient bounces using high-resolution BSDF or actual system geometry. The direct sun component is then added to the three-phase result with the direct sun removed. The five-phase method (Equation 4) uses an adapted version of the three-phase equation.

$$\mathbf{I} = \mathbf{V} \mathbf{T} \mathbf{D} \mathbf{s} - \mathbf{V}_d \mathbf{T} \mathbf{D}_d \mathbf{s}_{ds} + \mathbf{C}_{ds} \mathbf{S}_{sun} \quad (4)$$

$\mathbf{V}$  = View (interior) coefficient matrix

$\mathbf{V}_d$  = Direct view (interior) coefficient matrix

$\mathbf{T}$  = Transmission coefficient matrix (BSDF)

$\mathbf{D}$  = Daylight (exterior) coefficient matrix<sup>4</sup>

$\mathbf{D}_d$  = Direct daylight (exterior) coefficient matrix

$\mathbf{C}_{ds}$  = Coefficient matrix for direct sun relating radiance of many sun positions to direct illuminance at a sensor point

$\mathbf{S}$  = Sky vector containing average luminance of each sky patch including luminance of the direct sun

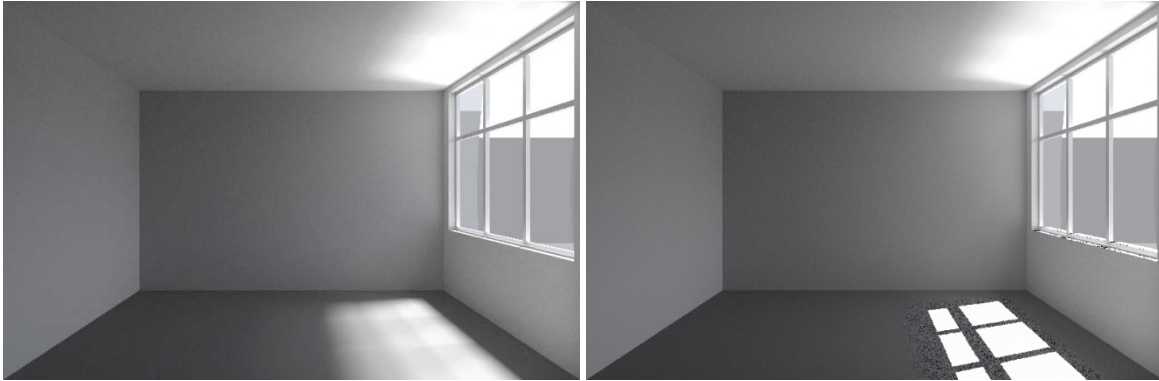
$\mathbf{s}_{ds}$  = Direct sun sky vector which contains only the sun luminance

$\mathbf{S}_{sun}$  = Direct sun matrix containing the radiance an position of the sun

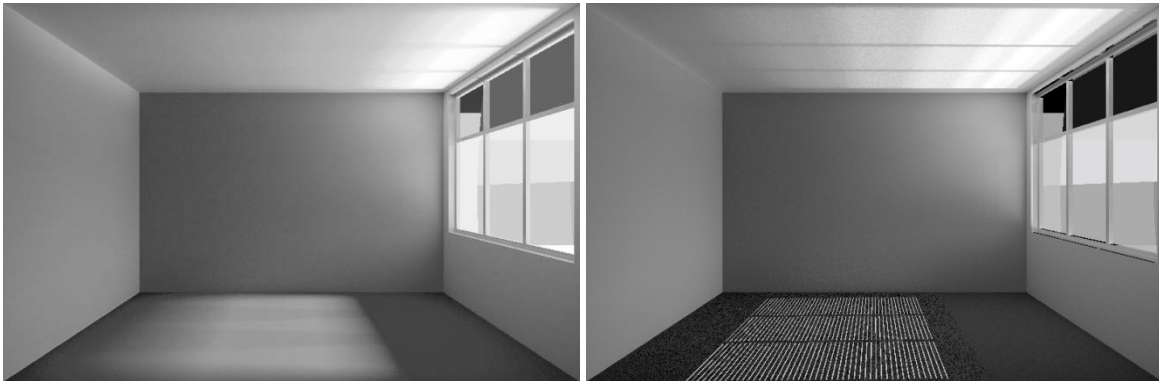


Figure 14 contains comparisons between a three-phase simulation and five-phase simulation results. Details of this method are documented in the tutorial (McNeil 2013b).

**Figure 14: Luminance renderings of a perimeter office space created using the three-phase method (left) and five-phase method (right)**



Clear glazing



Daylight redirecting louvers

Source: McNeil 2013b.

#### *2.2.3.4 Related developments*

Other related Radiance developments were made to speed up and broaden the capabilities and features of the new annual simulation tools.

##### *Accelerating three-phase annual simulations*

The project team redesigned the program that performs the matrix calculation to allow a full annual simulation in one call (rather than multiple calls—one per timestep). The optimized program reduces input/output (I/O) operation considerably, since the V, T, and D matrices (which do not change) are read into memory once. In addition, the VTD multiplication is performed only once (rather than for every timestep). These optimizations reduced the amount of time required for an annual matrix multiplication from six minutes down to a few seconds.

To support the annual matrix multiplication program, the program that generates sky vectors was adapted to generate an annual sky matrix. Originally the sky vector-generating program

used ray tracing to sample the sky luminance pattern; however, the new annual sky matrix generation uses analytical sampling providing another significant acceleration.

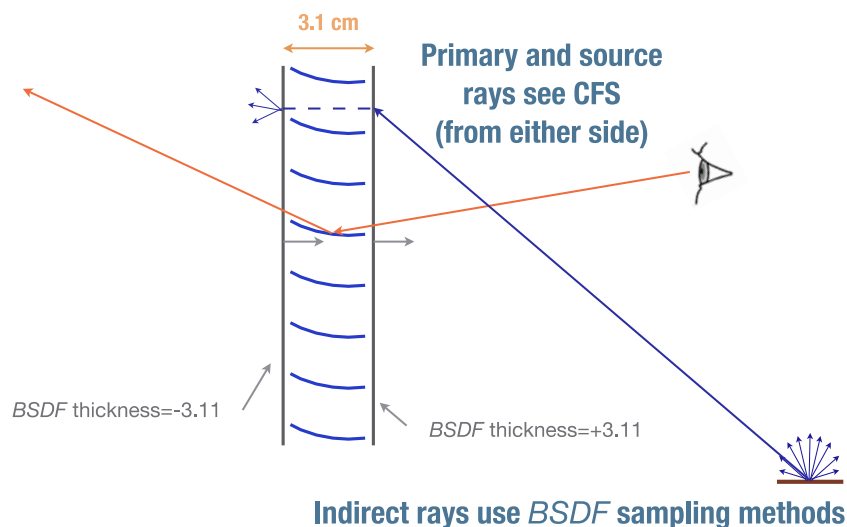
#### *Speed up with graphics processing units (GPUs)*

Graphics processing unit (GPU) processors have recently become more common on standard desktop computers, enabling significant increases in simulation speed if the software is written to optimize use of the parallel computing hardware. A GPU implementation of the annual matrix multiplication step was created using OpenCL, which is the first open standard for parallel programming on heterogeneous hardware, including central processing units (CPUs), GPUs, embedded processors, and other processors. There was no speed-up for a single annual simulation; however, a parametric GPU implementation, which reads multiple V, T, D, and S matrices, demonstrated significant gains from GPU processing (Zuo et al. 2013).

#### *Radiance BSDF material (data-driven material model)*

The addition of a BSDF “material primitive” to Radiance allows users to use BSDF data to describe the optical reflectance and transmission of an opaque or transparent/translucent surface in Radiance scenes. A surface with a BSDF material type can be used as a proxy surface that conceals the geometry of the CFS system. When a direct sample ray strikes a BSDF surface acting as a proxy, the ray passes unaffected to interact with the system geometry behind. Thus, the system geometry itself is visible in the rendering and used to determine shadow rays for direct illumination, as would occur in the five-phase method. However, ambient and other indirect sample rays striking the proxy surface evaluate the BSDF and send sample rays according to the BSDF distribution for more efficient evaluation (See Figure 15).

**Figure 15: Example CFS with proxy geometry**



Direct rays (view and sunlight, colored yellow) see actual CFS, whereas secondary rays (blue) employ more efficient sampling via recorded BSDF.

Source: LBNL.

### *Incorporating control sensors in annual simulations*

Daylight-responsive electric lighting controls rely on photosensors to measure available light within the workspace so that the electric lights are dimmed proportionally, saving energy. Radiance has a tool for simulating photosensors. The *rsensor* program takes a measured sensitivity profile for a given sensor and computes the signal output in a simulated environment. Originally, this computation would work only at a specific point in time, but *rsensor* now has a mode where it produces a set of distributed samples that may be used in the three-phase method to efficiently compute the sensor output for a particular sky condition via our matrix formulation.

### *Coordination with third-party developers*

There are few Radiance end users who have the expertise to use Radiance within the Linux environment. Most engineering professionals use Radiance through a third-party graphical user interface—Daysim, OpenStudio, and other versions in the European Union (EU). This project enabled us to work with third-party developers to bring new Radiance CFS capabilities into Radiance-based tools. Several meetings were held where Daysim and OpenStudio developers came to LBNL for updates on new capabilities and assistance with adapting new Radiance simulation workflows into their tools, including the five-phase method. Radiance updates were also incorporated in LBNL’s COMFEN tool (see Chapter 5).

#### 2.2.4 Virtual Prototyping Using Optimization Software

The ability to characterize the optical performance of a CFS by simulation and to quickly simulate annual daylight performance lends itself to iterative design and optimization. LBNL’s Genopt can be paired with Radiance and the new Radiance CFS capabilities to computationally find optimal CFS designs using a combination of parameterization and genetic algorithms. This modeling capability can significantly reduce the cost of early-stage R&D, enabling simultaneous development of prototypes and assessment of energy-savings potential for informed business decisionmaking.

The challenge of design via optimization is to (a) define a parametric model where the parameters predictably influence performance, and (b) create an objective function that effectively balances opposing metrics (e.g., visual comfort versus efficiency). In terms of parameterizing the model, we found that changing from parameters that were not directly mapped to outcome to parameters that mapped directly to outcome improved optimization results considerably. For example, using X and Y vector components for a reflecting surface does not map well to direction and amount of redirection. Conversely, angle and length of the surface have a straightforward mapping: angle influences direction and length influences amount of redirection.

Similarly determining a suitable objective function proved challenging. The metrics that were minimized were hours of discomfort glare ratings above a threshold and lighting energy use. Determining an appropriate trade-off between glare and lighting energy use was not simple. For example, is 1 percent more hours of glare worth the same, more or less than 1 percent lower

lighting energy use? For this study, the objective function allowed up to 3 percent annual hours of glare with no penalty but a 2x penalty for glare occurrence above 3 percent.

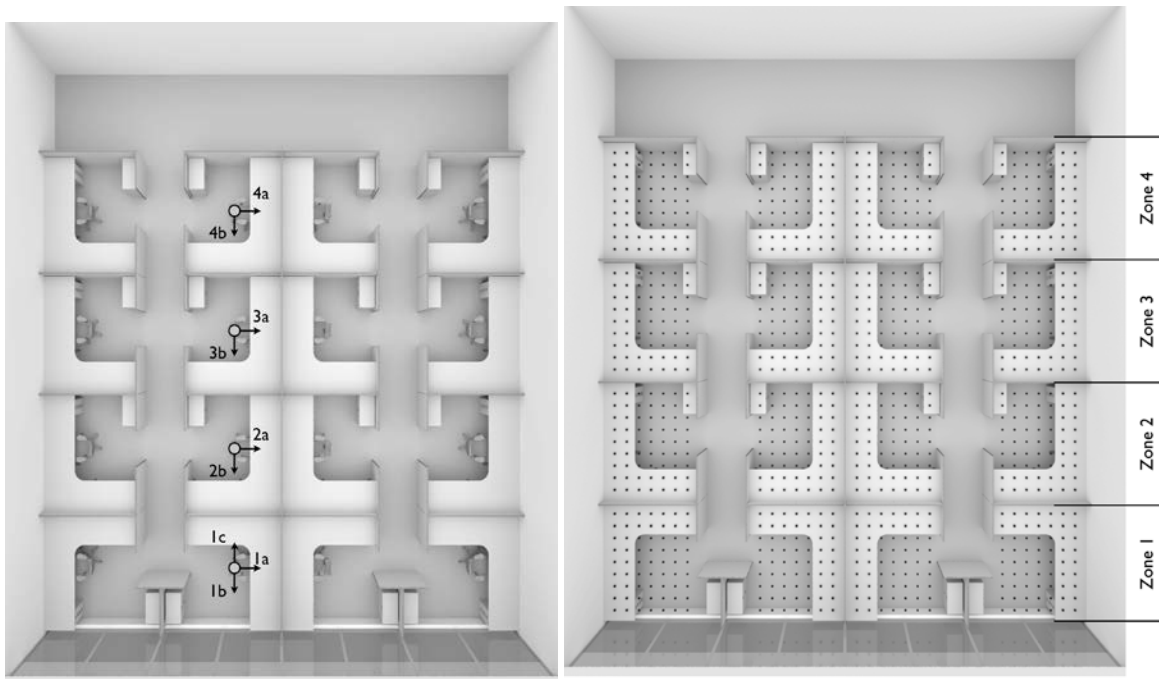
In addition, there was considerable difficulty finding a suitable proxy metric for glare. Simulating illuminance over a year for a grid of 1,600 sensor points was fast (< 8 seconds [s]) so annual lighting energy consumption could be used in the optimization loop without the need for a proxy metric. However, running all the renderings required for the full glare analysis required up to seven CPU hours. Using an annual glare metric in the optimization loop was prohibitively expensive. A simplified glare metric was used (daylight glare probability simplified [DGPs]) as a proxy for glare in the optimization loop, but was found to be poorly correlated to the actual annual DGP value. The final optimization workflow involved computing DGP for each Monday of the year, thereby reducing the glare analysis to about one CPU hour, resulting in a more acceptable correlation with annual DGP.

### 2.2.5 Modeling Approach for Technology Assessments

The Radiance simulation modeled an open plan office space (Figures 16 and 17) based on the DOE prototype large office building. Percent glare occurrence was defined as the percent of occupied hours (8 am–6 pm) when glare was experienced at one or more of the view points (Figure 16). Both DGP and daylight glare index (DGI) were used to evaluate glare occurrence. Fractional lighting energy use was defined as one minus the difference between the mean illuminance in a zone divided by the target illuminance in a zone integrated over the year for all four zones (Figure 16 for illuminance zones). The setpoint illuminance was 50 footcandles (fc) (500 lux).

With daylight redirecting systems, light leaving the window just above horizontal provides the deepest redirection while light leaving the window just below horizontal provides the worst glare. Simulations used a modified version of the Klems angle basis, called the Klems horizontally divided angle basis, to address the disparity between light above and below horizontal. The modified version of the angle basis has a clear horizontal division created by rotating each theta band by one-half patch and dividing the normal patch into two patches (Figure 18).

**Figure 16: Floor plan view of the modeled open plan perimeter office**



Floor plan view of the open plan perimeter office showing locations and directions of the nine views used for glare assessment (left) and locations of the workplane illuminance grid points and zone boundaries (right).

Source: LBNL.

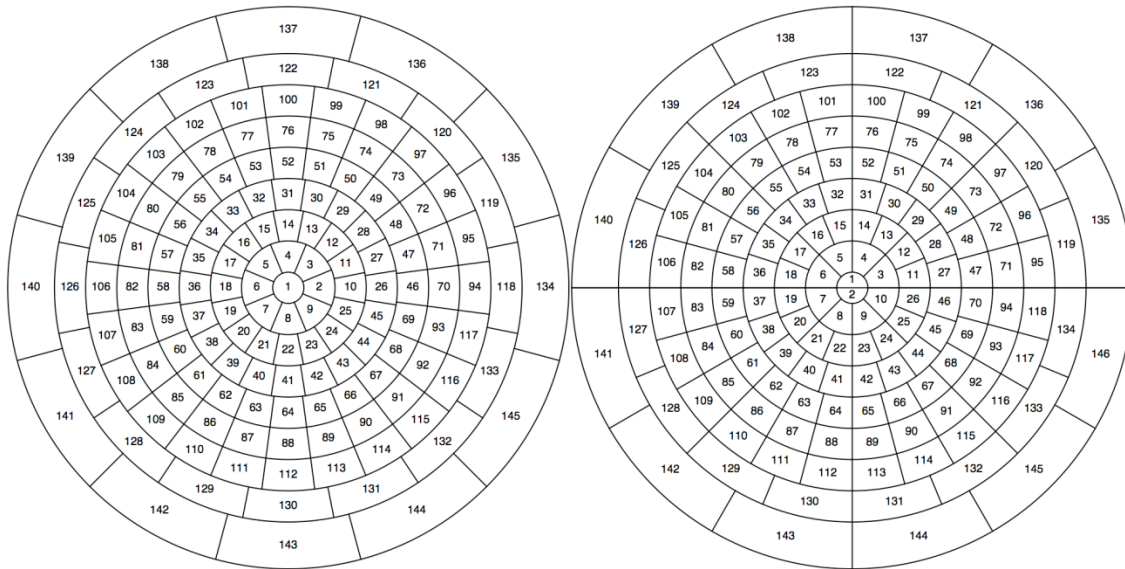
**Figure 17: Exterior elevation of the simulated model**



Elevation shows the division between upper clerestory and lower view glazing.

Source: LBNL.

**Figure 18: Klems horizontal angle basis**



Diagrams showing divisions of the full Klems angle basis (left) and the modified Klems horizontal angle basis (right).

Source: LBNL.

## 2.3 Technology Research and Development

### 2.3.1 Passive Optical Light Shelf

#### *Approach and Goals*

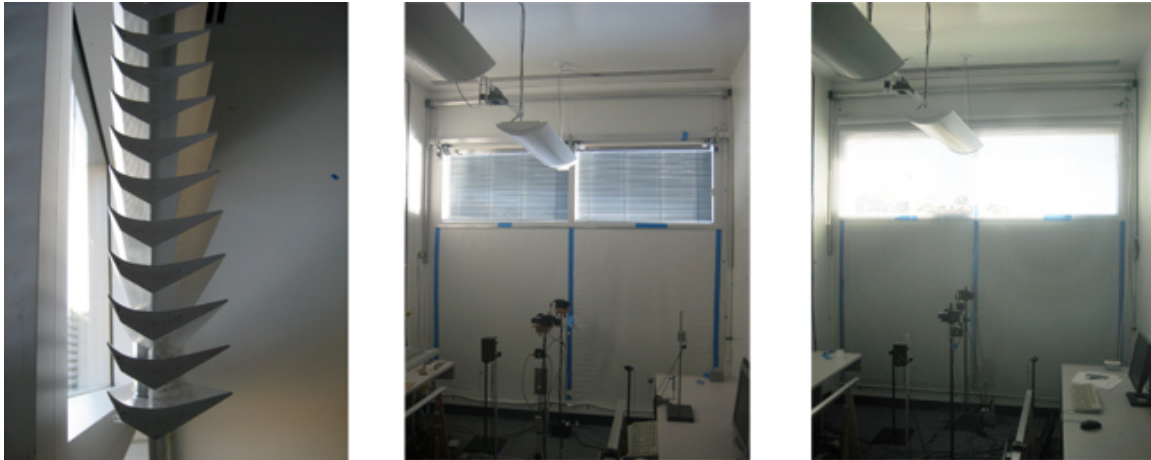
A simulation study was conducted to evaluate the performance of a commercially available, passive optical light shelf which has been installed in many buildings over the years but has not yet achieved significant market penetration (less than 1 percent of the California and U.S. commercial building stock) in part because of its unknown performance impacts on lighting energy use and visual comfort (McNeil and Lee 2010). The 2010 study was one of the first uses of the newly developed three-phase annual simulation capability described in Section 2.2. The study served to benchmark the energy-efficiency performance of existing daylight-redirecting systems against existing practice and to identify market barriers early on in the project. A field study was also conducted to evaluate discomfort glare and lighting quality. A small demonstration of the technology was conducted in an existing office building in Sacramento, California.

#### *Outcomes*

The passive optical light shelf is a commercial product (LightLouver LLC (Rogers et al. 2004)), consisting of multiple 0.062 m (2.4 inch [in.]) wide, vertically-stacked, concave-up, reflective slats. A reflective film was applied to the concave-up surface and the sloping surface facing the space. The reflective slat geometry was designed to redirect incident sunlight uniformly onto

the ceiling and to block sunlight below a 5° solar altitude angle to reduce glare. The system is completely static (passive), requiring no adjustment over the year, and is typically installed in the upper portion of the window at a minimum of 2.1 m (7 ft) above the finished floor. The system completely obstructs view to the outdoors (Figure 19).

**Figure 19: Photographs of passive optical lightshelf in Advanced Windows Testbed**



Left: Side view of the OLS prior to being installed on the inward face of the clerestory glazing. Middle: Indoor view of the passive optical light shelf. Right: Indoor view of the venetian blind reference condition. Source: LBNL.

Performance was evaluated using parametric Radiance simulations of a south-facing, open plan office perimeter zone (McNeil and Lee 2010<sup>5</sup>). The light shelf was compared to the same window with or without a conventional indoor venetian blind. Daylight availability was evaluated using two metrics that indicate percentage of daylight hours when the workplane illuminance exceeded the 500 lux threshold (i.e., continuous daylight autonomy and useful daylight index). Frequency of discomfort glare over a year was also evaluated annually from multiple view points within the perimeter zone.

Total perimeter zone lighting energy use was determined from the average of the lighting control zones and expressed as fractional lighting energy use where 1.0 is the lights on at full power and 0.0 is with the lights off all hours. Annual fractional lighting energy use was determined for daytime office work hours from 8:00-18:00 local time (LT) for all days of the year. Annual fractional lighting energy use was 0.64 for the optical light shelf and 0.72 for the venetian blind (11 percent savings) for the 12 m (40 ft) deep south-facing zone in Sacramento. Both systems produced no occurrence of discomfort glare over the year.

A field test was conducted in the LBNL Advanced Window Testbed (Berkeley, California) from February to August 2010 (Konis and Lee 2011). Results differed from that of the simulations

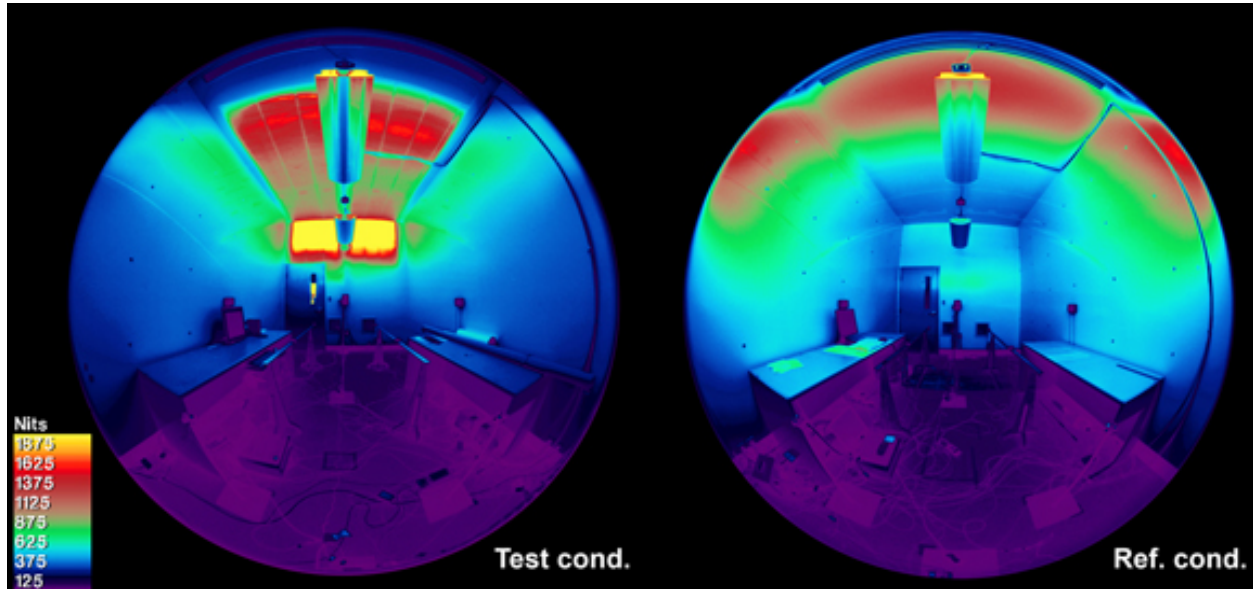
---

<sup>5</sup> The modeling approach from this earlier study is not the same as later studies so savings in this final report are given for the latest modeling approach described in McNeil et al. 2013d).



because the field test was conducted in a 4.6 m (15 ft) deep private office instead of the open plan work area simulated in Radiance (Figure 20). Findings for discomfort glare were given for a view looking toward the window from the rear wall of the room, as might occur with seated occupants in open plan offices. The lower window was covered with black-out cloth to isolate findings to the upper daylighting aperture.

**Figure 20: Luminance maps of passive optical light shelf in Advanced Windows Testbed**



High dynamic range luminance map of test optical light shelf condition (left) and reference venetian blind condition (right) looking toward rear wall of room acquired near-simultaneously on February 7, 2010 at 12:22 pm (clear sky conditions) with falsecolor tone mapping (yellow indicates luminance  $\geq 2000$  cd/m<sup>2</sup>). The light shelf is redirecting sunlight to the upper section of the rear wall 15 feet from the window. Electric lights are off.

Source: LBNL.

The light shelf was found to produce fewer hours (between 0.25–1.5 hours per day) of daylight autonomy than the venetian blind, but the light shelf never exceeded the designated threshold for window glare.<sup>6</sup> The light shelf was also found to direct significantly more daylight to the ceiling during the middle of the day (between 10 am and 2 pm) compared to the venetian blind: 69 percent more under clear sky conditions and 30 percent more under overcast sky conditions (Figure 20). Non-optimal daylight performance occurred during periods when the sun was at an oblique angle to the window (e.g., early morning or late afternoon). For the simulations and the field test, the manufacturer indicated that the ceiling height was only about half of the required height needed to meet the daylighting requirements of the deep perimeter zone (i.e., a ceiling height of 3.35 m (11 ft) would have been required).

<sup>6</sup> It was not possible to determine daylight glare probability (DGP) at the time, due to incompatibilities between the evalglare software and the image format produced by the digital cameras.



The light shelf was installed as a retrofit measure in June 2010 on the inside of south-facing windows and used to daylight an open plan office area in an existing office building in Sacramento. Anecdotal comments from the occupants a year later indicated satisfaction with the lighting quality in the space despite the reduced access to view.

The optical light shelf provided sufficient incentives to continue to conduct research in this area: 20 percent savings in annual lighting energy use in the 5.8–17.4 m (19–57 ft) deep zone from the perimeter, minimal impact on discomfort glare, and improved indoor lighting quality due to increased brightness within the entire room cavity. There were several other technologies also worth investigating that had the potential of providing similar or greater benefits.

Microprismatic films could be manufactured at potentially lower cost and be applied as a retrofit measure to the existing window. Advances in materials R&D for dynamic metamaterials held the potential of providing leapfrog advances in performance over conventional daylighting approaches.

### 2.3.2 Switchable Daylight-Redirecting Glazings

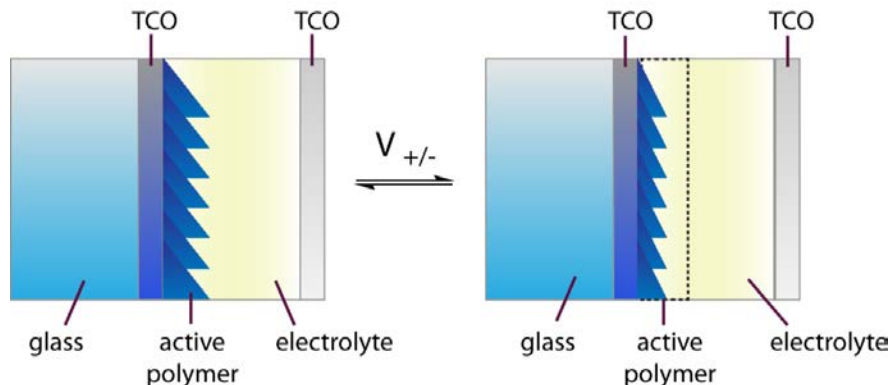
#### *Approach and Goals*

Like the electrochromic glazings now emerging on the market, microscale, *switchable* daylight-redirecting glazings have the potential for widespread application if a low-cost, durable coating can be engineered and manufactured with the proper set of attributes. The optical characteristics of inverse opals made from soft materials have recently been shown to be tunable over a broad range through mechanical deformation (Xia et al. 2005). The active material consists of a redox-activated polymer, such as polyferrocenylsilane, either as a single component or as a constituent in a blend with an optically transparent flexible matrix which permits chemical tuning of the refractive index. These polymers exhibit a large electromechanical response, e.g., 20 percent strain (McDowell et al. 2010), which has been used to tune the defect structure in a polymer opal electrically (Fleischhaker et al. 2005).

Prototype structures can be fabricated from these electroresponsive polymers by nanoimprinting or nano-hot embossing methods which are applicable to large areas and fine feature resolution and are compatible with low cost in-line industrial manufacturing processes. Such methods have been developed by LBNL material scientists and have been applied to patterns with high resolution and high repeatability over large area functional materials as polymers and sol-gel derived inorganic materials.

If dynamic glazings based on electroactuated optical metamaterials can be realized, daylight redirection and diffraction efficiency could be externally modulated (e.g., via an applied voltage) to track the angle of incident sunlight, thereby optimizing lighting energy savings over a larger fraction of building floor space and responding to the needs of building occupants (Figure 21).

**Figure 21: Electroactuated metamaterials for dynamic daylight redirection**



Electroactuated coatings prepared from inexpensive, scalable redox active organometallic polymers and self assembled colloidal crystal. Diffracted component of sunlight controllable through morphology changes in, for example, an active polymer induced by electrochemical means.

Source: LBNL.

A separate study funded within LBNL was conducted to develop the dynamic daylighting materials, characterize optical performance, and evaluate energy performance potential with cost-share from DOE. Radiance simulations were used to provide design guidance for material science developers and to quantify the technical potential for reducing U.S. energy use (Shehabi et al. 2013).

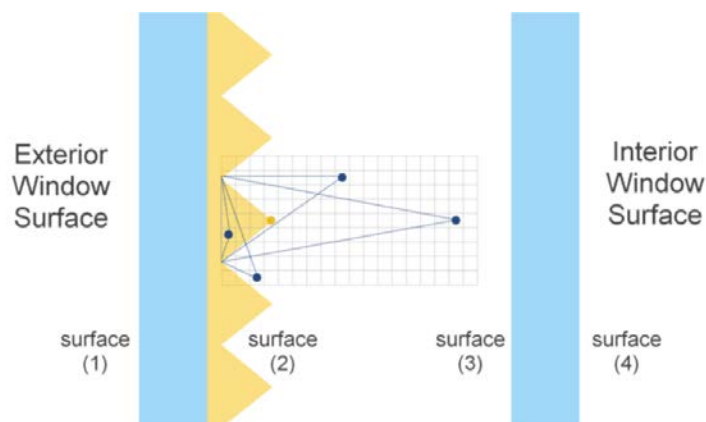
#### *Outcomes*

Simulations are critical to establish the target geometries, refractive indices, and optional partial metallic coatings for the dynamic structures. For study of the optical response of nano- and mesoscale functional coatings, finite-difference time-domain (FDTD) and finite element method (FEM) electromagnetic simulations can be used to guide iterative design and to quantitatively engineer nanophotonic structures. Such simulations were conducted to produce transmission and reflectance data and two-dimensional angular scattering distribution data, which were then compared to design objectives. The approach was determined however to be impractical (>1 year computation time) for producing the three-dimensional, full BSDF data needed to simulate annual daylighting performance. Instead, FDTD simulations were used to provide guidance on the scale and shape of gratings that would produce significant light redirection. Direct measurements of fabricated materials were prevented by sample size, which were too small for the spectrophotometer and scanning goniophotometer.

Due to the lack of characterization data, a simulation study was conducted in parallel to evaluate the energy savings potential of an idealized dynamic prismatic device that could permute its triangular profile from a compact to elongated form. At each timestep, one of 207 possible prism shapes was selected based on a filter that identified the shape that resulted in the greatest average work plane illuminance within discomfort glare constraints. Results were

determined for 30° and 40° north latitudes. These optimal benchmarks were used to guide further developments of daylighting-redirecting systems throughout this project.

**Figure 22: Model of dynamic prism**



Dynamic prismatic coating on surface 2 with the apex of alternate potential prism shapes drawn in blue over the grid of all possible apex positions.

Source: LBNL

Dynamic metamaterials of this specification are unlikely to be realized for many years to come. Automatically controlled, sunlight-redirecting systems such as motorized reflective blinds or prismatic louvers can, however, achieve a comparable level of energy savings in the near term. These systems are commercially available but have low market adoption for a variety of reasons, including cost and complexity. We investigated static microprismatic films as a low-cost alternate for potentially broad market adoption in the retrofit market.

### 2.3.3 Microprismatic Sunlight-Redirecting Films (3M)

#### *Approach and Goals*

Surface relief-microstructured windows films such as holographic diffusers, holographic optical elements, diffraction gratings, and prismatic structures are a relatively mature technology that can be made applicable to the retrofit market at low cost. The films are made through embossing, with surface textures of depths between 10 nanometers up to 200 microns, and are manufactured in a cleanroom environment via roll-to-roll processes with widths that are applicable to large-area windows (e.g., 2 m). The substrate film can be composed of multiple layers of acrylic (polymethyl methacrylate or PMMA), polycarbonate, or other materials that are not susceptible to degradation under prolonged exposure to sunlight. The daylight film can be combined potentially with solar control films in a multilayer system that achieves both solar and daylight control.

In mid-2011, LBNL and 3M agreed to collaborate on the evaluation of 3M's prototype, micro-structured, prismatic film designed to redirect sunlight through vertical windows. The "P1" film is clear (although views through the film are distorted) and patterned with linear, 50-250

micrometer high, four-sided asymmetrical prisms. 3M had developed an aggressive business plan to promote the film in the commercial market in the near term and was interested in having LBNL quantify potential performance impacts prior to market release.

Samples of the film were measured using optical imaging and the goniophotometer, and an analysis of these data was conducted to determine whether its redirecting properties met basic performance criteria. Simulations were then conducted to assess annual lighting energy savings and discomfort glare performance in a deep open-plan perimeter office zone. The film was also evaluated in the Advanced Windows Testbed. In parallel, 3M conducted full-scale demonstrations of the film in several Army buildings through the U.S. Department of Defense Environmental Security Technology Certification Program, in collaboration with HMG (ESTCP 2013). LBNL shared the characterization data with HMG so that they could conduct their own independent simulation analysis.

### *Outcomes*

Fabrication using roll-to-roll techniques can result in profiles that do not perfectly replicate the intended design. At the time of the analysis, it was impractical to measure all incoming incident angles with the scanning goniophotometer; it simply took too much time. Instead, two profiles were traced from optical scans of the fabricated film, and these profiles and the original design were modeled using the Radiance *genBSDF* ray-tracing tool to generate an average BSDF dataset that was used for the simulations. This synthesized BSDF dataset agreed largely with measured data taken with a scanning goniophotometer; in-plane direct-hemispherical intensities agreed well across the range of incident angles ( $\theta_i = 0-90^\circ$ ,  $\phi_i = 90^\circ$ ) and the peak transmitted energy was found to occur in the same outgoing patch for incident angles between  $20^\circ-70^\circ$ .

Early outcomes from full-scale field measurements of the P1 film in the LBNL Advanced Windows Testbed revealed that the film produced discomfort glare when facing the window, primarily due to direct views of the sun's orb through the film (Figure 23). 3M provided a second film that diffused the outgoing light without substantially changing its direction. The second film was placed parallel to and on the indoor side of the original P1 film. This dual-film system, called "P2," was also measured using the goniophotometer and modeled using the three-phase method with low-resolution BSDF data (Klems 145 x 145 basis).

**Figure 23: Daylight distribution from reference and daylight redirecting systems**

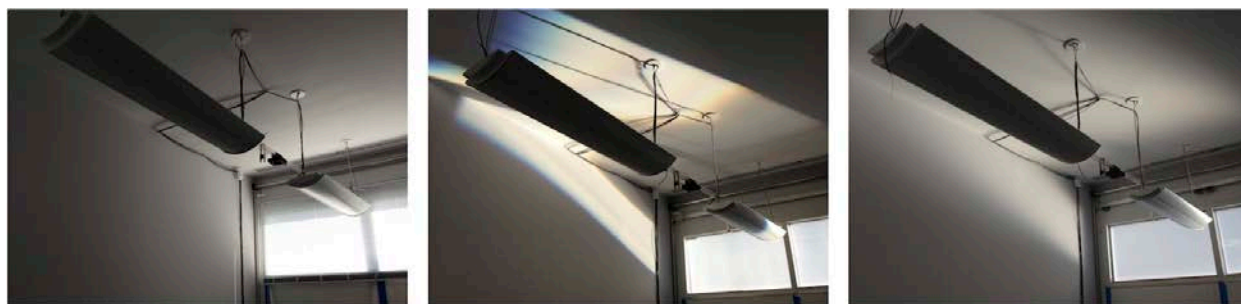


Photo of reference venetian blind (left), P1 system (middle), and P2 system (right) in the Advanced Windows Testbed. Images are given for February 7, 2013 at 14:00 (solar altitude = 29.60°, solar surface azimuth angle = 146.3°) clear and sunny sky.

Source: Thanachareonkit et al. 2013.

Annual lighting energy savings due to the P2 system were appreciable. Annual fractional lighting energy use was 0.58 for the P2 system and 0.72 for the venetian blind (19 percent savings) for the 12 m (40 ft) deep south-facing zone in Sacramento. Compared to Title 24 2013 with an installed lighting power density (LPD) of 0.75 W/ft<sup>2</sup> and daylighting controls in the 0-10 ft zone nearest the window, savings in a south-facing 12 m (40 ft) deep perimeter zone were 59 percent, 53 percent, 17 percent and 6 percent in the 0-10 ft, 10-20 ft, 20-30 ft, and 30-40 ft zones from the window, respectively, in Sacramento. Total source<sup>7</sup> lighting energy use savings were 1.5 kWh/ft<sup>2</sup>-yr (28 percent). Savings were even greater compared to Title 24 2008: total source lighting energy use savings were 3.44 kWh/ft<sup>2</sup>-yr (41 percent). Source peak electric demand reductions over the 40 ft deep zone were 0.26-0.48 W/ft<sup>2</sup> (27–49 percent) compared to Title 24 2008 in Sacramento and Burbank, California, with the greater savings occurring in Burbank. Estimated simple payback ranged from two to six years, assuming an added installed cost of \$20/ft<sup>2</sup>-window to the consumer.

The P2's diffusing film reduced discomfort glare compared to the P1 system to some extent, with an estimated frequency of glare occurrence at 9.5 percent of annual hours for the worst-case view position within the open plan perimeter zone (south, Sacramento). An arbitrary maximum of 5 percent annual occurrence of discomfort glare during the day (3 weeks) was set as the target goal for acceptable performance. The glare assessment was conservative: no electric lighting was modeled in the simulations, so the level of adaptation in the rear of the perimeter zone is likely to be less than if the zone had supplementary electric lighting.

Field measurements in the LBNL Advanced Windows Testbed largely confirmed the trends noted in the simulations. The spaces were not comparable in depth, and therefore the findings are not directly comparable. Like the simulations, the P1 system was found to result in perceptible levels of discomfort glare, while the P2 system controlled glare to imperceptible levels over the course of clear sunny days from the most conservative view point in the rear of

---

<sup>7</sup> The site-to-source electricity conversion factor was 3.3.

the room looking toward the window. Differences in the discomfort glare assessment between the field measurements and simulations could be due to the position of the view points; the field measurements were closer to the window, so background luminance levels and adaptation levels would have been higher compared to the 12.2 m (40 ft) deep space. Both were without supplementary electric lighting.

Monitored daylight illuminance levels at the rear of the 4.6 m (15 ft) deep room were significantly increased above the reference window condition, which was defined as the same glazed clerestory window but with an interior venetian blind (slat angle set to the cutoff angle), for the equinox to winter solstice period on clear sunny days. For partly cloudy and overcast sky conditions, daylight levels were improved slightly.

### 2.3.4 Microprismatic Sunlight-Redirecting Films (Dow Chemical)

#### *Approach and Goals*

Dow Chemical approached LBNL with prototype designs for a microprismatic daylighting film and requested assistance with its evaluation. The collaboration was mutually beneficial: LBNL claimed the new Radiance tools would save R&D effort on the part of industry when developing new technologies, and Dow Chemical served as a test partner to prove out these claims. The manufacturer was apprised of the modeling assumptions, characterization methods, and tools used for the performance assessment, including tutorial materials. A series of analyses was conducted on an iterative basis over a year-long period on about 20 different designs. Dow used the results of the analysis for internal planning and product development activities.

#### *Outcomes*

In the 1990s when the LBNL WINDOW and Therm tools were provided to industry, a whole host of innovative window and frame products were subsequently developed because these tools provided immediate, low-cost feedback to manufacturers on how changes to their designs improved performance. In the same manner, the Radiance tools developed in this project provided Dow Chemical with immediate feedback on the relative performance of various designs that then enabled them to evaluate their R&D activities and the potential value proposition to consumers. Dow Chemical voiced strong appreciation for the technical support, saying that the new modeling capabilities were invaluable for informed internal decisionmaking. Other industry partners have since voiced the same appreciation for the benefits the new modeling tools have brought to their business.

### 2.3.5 Virtual Prototyping Microprismatic Films

#### *Approach and Goals*

The optimization software described in Section 2.2.4 was used to determine whether the performance of microprismatic films could be pushed toward the performance levels achieved by the idealized dynamic prismatic device. The traditional approach to developing static designs has been to use ray-tracing software and first principles to come up with a design that redirects sunlight for the range of critical profile angles that occur over the year. This approach

was used by LBNL to develop the designs for a passive optical light shelf and light pipe system in the early 1990s (Beltrán et al. 1997). With the optimization software and the power of cluster computing resources, this tedious design process can be replaced with automatic generation and evaluation of tens of thousands of permutations on a design using the Radiance software. Accelerated convergence to an optimal solution within a multi-dimension solution space can be achieved using genetic algorithms. The 3M microprismatic film type was used as a test case, where the geometry and refractive properties were defined by the manufacturing limits provided by 3M.

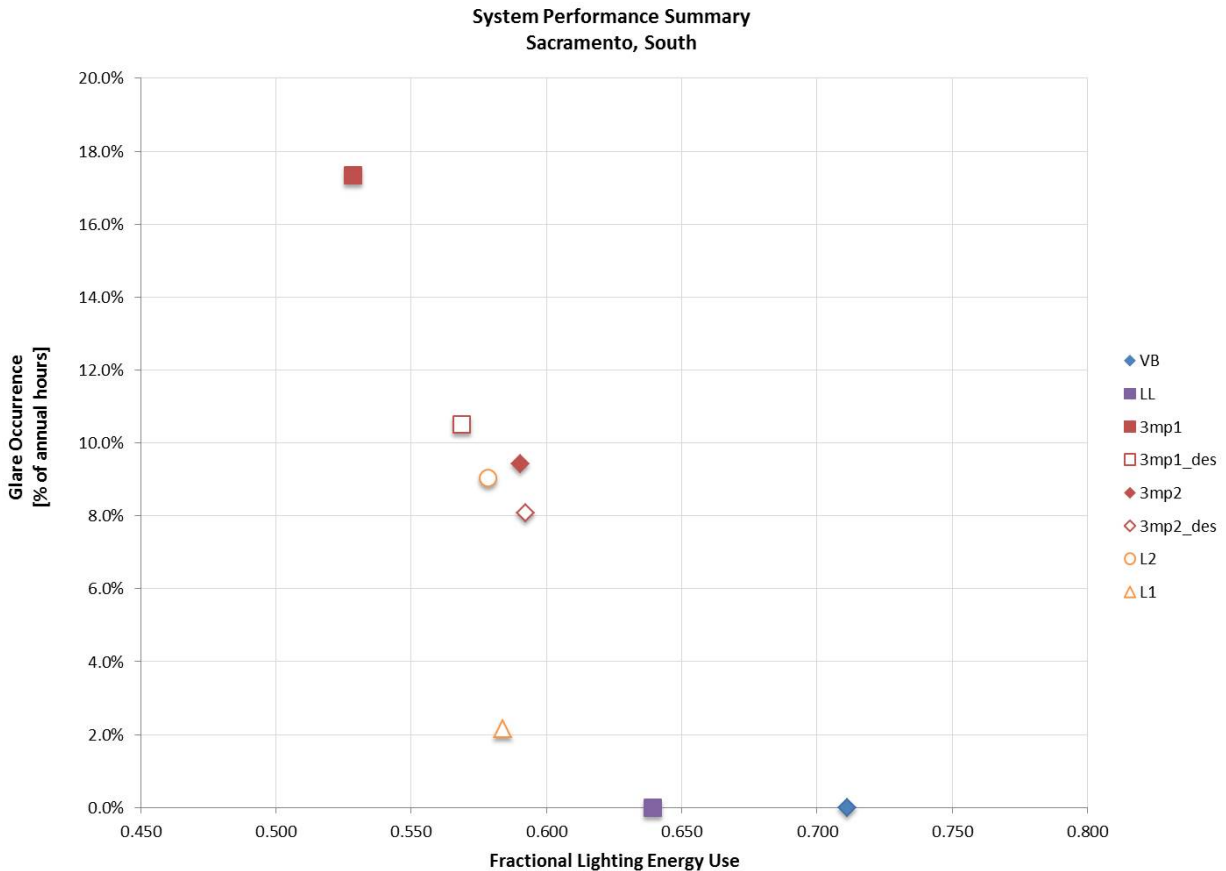
#### *Outcomes*

Many designs were identified that provided either greater energy savings or less discomfort glare, but not both. Because discomfort glare was defined as a constraint, only the designs that yielded an annual frequency of glare discomfort of less than 5 percent per year were qualified for consideration. Designs with the greatest lighting energy savings within this glare constraint were submitted to 3M for fabrication, so that we could test the sample in the full-scale testbed.

The installed configuration of the “L1” prototype was similar to the P1 prototype, in that the single layer of film is adhered to the indoor surface of a vertical clerestory window so that redirected sunlight would be redirected upwards toward the ceiling plane. But unlike both the P1 and P2 prototypes, Radiance simulations indicated that the L1 film produced significantly less discomfort glare, but with a single film (Figure 24). The P2 system requires the addition of a second pane of glass inboard of the existing window on which to mount the diffusing film, or replacement of the existing insulating glass unit with the new P2 two-layer system. Cost-effectiveness of the L1 system is therefore significantly greater than the P2 system with a small reduction in energy-efficiency performance.

Annual fractional lighting energy use was 0.57 for the L1 system and 0.72 for the venetian blind (21 percent savings) for the 12 m (40 ft) deep south-facing zone in Sacramento. Compared to Title 24 2013 with an LPD of 0.75 W/ft<sup>2</sup> and daylighting controls in the 0-10 ft zone nearest the window, savings in a south-facing 12 m (40 ft) deep perimeter zone were 63 percent, 47 percent, 12 percent and 1 percent in the 0-10 ft, 10-20 ft, 20-30 ft, and 30-40 ft zones from the window, respectively, in Sacramento. Total source lighting energy use savings were 1.27 kWh/ft<sup>2</sup>-yr (24 percent). Savings compared to Title 24 2008 were 3.15 kWh/ft<sup>2</sup>-yr (37 percent) in Sacramento. Frequency of discomfort glare was significantly less with the L1 system: 2 percent occurrence of glare per year. Note that in Figure 24, simulated performance varied depending on whether the BSDF was derived from profilometry scans of the fabricated sample or from the original design. Energy savings for P2 are given for the fabricated samples while results for the L1 system are given for the original design.

**Figure 24: Chart summarizing performance of the 3M P1 and P2 films, the L1 film prototype, commercially available passive optical lightshelf (LightLouver), and venetian blind (VB)**



Performance given for the reference venetian blind (VB), LightLouver (LL), 3M P1 and P2 systems, and LBNL L1 and L2 systems. Simulations for the P1 and P2 systems were based on either BSDF measured data of the fabricated sample or the original design (“\_des” on the legend above). L1 and L2 simulations were based on the original design.

Source: LBNL.

While the original intention was to have 3M fabricate the L1 prototype for field testing, the manufacturer fabricated L2 design instead because it better met the constraints of their manufacturing capabilities. The magnitude and frequency of discomfort glare for the L2 system was therefore greater than the L1 design.

## 2.4 Conclusions and Recommendations

### 2.4.1 Conclusions

Daylight-redirecting systems have significant technical potential to reduce lighting energy use and peak electric demand in 12 m (40 ft) deep, south-, east-, or west-facing perimeter zones. The magnitude of energy savings is determined by how well a system manages the trade-offs between daylight admission and discomfort glare. A commercial optical light shelf system



eliminated discomfort glare throughout the year but provided less energy savings than microprismatic films. An early film design by 3M (P1) provided significantly greater energy savings than the P2 system but also significantly increased frequency of discomfort glare. The L1 design provided significant lighting energy savings and managed discomfort glare to within acceptable limits. Annual source lighting energy use savings for the 12 m (40 ft) deep space were 37-41 percent compared to Title 24 2008 for the P2 and L1 designs in Sacramento.

With respect to indoor environmental quality, the daylight-redirecting systems increased room cavity luminance by illuminating the ceiling with sunlight, balancing daylight admitted through the lower clerestory windows. Indoor illuminance levels were increased significantly and varied on a temporal and seasonal basis, depending on sky conditions and solar position. The quality of illumination and the connection to the outdoors is expected to result in intangible positive benefits related to occupant satisfaction, productivity, and health, but there are no measured data from this study with which to support this claim. Views to the outdoors are completely obscured by the passive optical light shelf and are diffused by the microprismatic film. Unobstructed views are provided by the lower window.

There have been several demonstration projects conducted by others to evaluate the microprismatic film, but the manufacturer reported that the occupant response data were somewhat inconclusive. For the one installation that this project was involved with, there were positive comments made anecdotally about the passive optical lightshelf; a thorough investigation was not conducted.

The non-uniformity of daylight patterns across the ceiling may be of concern to lighting designers or others who are trying to create special areas of interest or focus with lighting. The system produces regions of brightness that taper in intensity across the ceiling. Since the daylight is redirected at a glancing angle, ceiling-mounted sensors or pendant light fixtures that project down from the ceiling create shadow patterns and potentially reflected glare, if the surface finish of these objects are metallic or shiny.

The systems are designed to be installed in the upper clerestory portion of the window wall and as such, results in a particular aesthetical appearance both from the inside and outside of the building. For new construction, the systems can be accommodated as part of the window design. For retrofit construction, window details need to be worked out. If the system is hung inboard of the existing window glazing from the ceiling, then interior shades for the lower window must be installed below the clerestory aperture on either the existing window framing or on a horizontal support added to the window wall.

If the glazing is deeply set back from the façade, then the upper clerestory will be shaded by the façade and window framing, reducing the effective area for daylighting the interior—particularly for buildings in low latitudes. Solar control elements such as overhangs, fins, screens, and fritted glass, and outdoor obstructions such as trees and nearby buildings will reduce effectiveness of these systems. Similarly, an interior space designed for daylight can increase effectiveness of this technology: e.g., use of high ceiling and wall surface reflectances,

low-height open plan office furnishings, minimal use of opaque walls parallel to the window and between the window and the core of the perimeter zone.

These systems are applicable to existing buildings with windows that have a relatively high visible transmittance ( $T_{vis}$ ), ideally greater than 0.50. The daylighting systems can still work with windows with a lower visible transmittance: there are more-than-adequate indoor daylight levels ( $> 1,000$  lux) when it is sunny and direct sunlight is being redirected by the system, but daylight levels will likely be inadequate when outdoor conditions are overcast or when the sun is not in the plane of the façade. For the light shelf system, optical performance is related to how well the system is maintained free from dust and dirt on its reflective surfaces. Similarly, the microprismatic window film can lose efficiency if not protected against abrasion, dust, and dirt.

Use of virtual prototyping tools demonstrated the potential for developing new designs that more optimally balance the trade-offs between daylighting and discomfort glare. Adequate models for evaluating discomfort glare are critical to the derivation of these new technologies. More detailed studies are needed to determine whether advanced modeling tools such as the five-phase method and variable-resolution BSDF datasets will significantly increase the accuracy of the discomfort glare calculations.

Prior to this project, modeling of daylighting technologies have been limited to point-in-time calculations using assumptions about the light-scattering properties of the systems. New algorithms in Radiance now enable stakeholders to determine the annual energy use and discomfort impacts of a vast array of optically complex fenestration systems using measured bidirectional transmittance and reflectance data. The modeling tools produce accurate data within a practical time frame of hours rather than weeks or months. By collaborating with third-party developers of interfaces to the Radiance engine, these new capabilities have been incorporated into DaySim and OpenStudio, making these developments more accessible to the lighting design community. With the expansion of prescriptive requirements to use daylighting controls on electric lighting systems throughout nonresidential buildings in Title 24 2013, it will become equally important to encourage adoption of fenestration systems that extend the benefits of daylight well beyond the conventional sidelit perimeter zone depth of 10–15 feet.

#### 2.4.2 Recommendations

There are many macroscaled daylighting technologies that have been developed over the past 30–40 years, but few have remained on the market; possibly because historically, there has been little demand for such technologies. Recent investments by major U.S. corporations to develop macroscaled versions of this technology at low cost have opened up the door for more innovative, low-cost products to enter the market. With the increased pressure exerted by energy-efficiency codes and standards to use daylighting controls, the demand for fenestration products that enhance daylight may increase. Since having an array of options creates a more competitive market environment and exerts downward pressure on the cost of technologies, it would be useful to continue to support further development and deployment of this emerging technology.

This project has shown that static systems can deliver significant reductions in lighting energy use at low cost. Dynamic sunlight-redirecting systems were field-tested in Phase I of this project, demonstrating that motorized reflective louvers can provide significant savings as well. Such systems or systems of similar design intent may be able to deliver the performance levels of the hypothetical dynamic system modeled in this study. It would be worth investigating this class of technologies further to determine if an optimized daylighting component combined with optimal controls could deliver a glare-free, highly efficient system at low cost.

Further work is needed to better understand user acceptance, satisfaction, and comfort associated with daylight-redirecting technologies. Further work is also needed to develop more robust discomfort glare models based on subjective data.

Radiance tools and methods of characterization will require further development and validation as new classes of technologies emerge. Radiance models that use variable-resolution BSDF datasets should be validated with measured data to verify the accuracy of predicted luminance distributions, particularly for use with glare models.

### 2.4.3 Commercialization Potential

In 2012, 3M began to actively market its product through trade shows and on its website. They developed partnerships with window manufacturers to develop product options for both new and retrofit applications. 3M indicated interest in LBNL designs, and as of the conclusion of this project, was considering licensing the technology. A daylighting film would perhaps have the broadest applicability in the market if it could be applied to the indoor surface of the window as a retrofit technology and offered at a reasonable price. The LBNL L1 prototype demonstrated that such solutions are possible. LBNL provided 3M with both the Radiance model and technical support so that 3M could conduct its own in-house simulations as it continued to develop new designs and manufacturing methods to better meet market needs.

At present, manufacturers are seeking demonstration opportunities that could raise market awareness for this emerging technology and demonstrate its benefits.

### 2.4.4 Benefits to California

Daylight-redirecting systems applied to the upper clerestory area of windows reduce lighting energy use in both the perimeter and core zones of buildings, particularly in sunny climates like California. Significant lighting demand reductions occur during summer peak periods, particularly for south- and west-facing orientations when the sun is near or at normal incidence to the façade and daylight-redirecting is at its peak efficiency. The static technologies are passive and will daylight core zones even in the event of power outages. Because these technologies are used in a small area of the window, they can be coupled with solar control glazing and displace heat gains from electric lighting. Negative impacts on cooling energy use and demand are expected to be minimal.

The quality of daylight from these systems is probably one of the most pleasant aspects of this technology. For core zones that are typically non-daylit, this technology provides occupants with a sense of the time of day and patterns of weather that are occurring outside the building. Some systems even introduce a little chromatic dispersion, producing a rainbow effect at the

edges of redirected sunlight. These qualities could enhance occupant satisfaction with their indoor environment and have other beneficial impacts on health and productivity.

# CHAPTER 3: Angular-Selective Shading Systems

## 3.1 Introduction

Solar radiation through windows can have positive benefits, such as providing enough daylight that electric lighting can be turned off during parts of the day, as discussed in Chapter 2, or drawbacks, such as increased air-conditioning to cool the interior due to excess solar heat gains. This makes solar control, the technique of reducing the admission of unwanted solar radiation, an important feature of energy-efficient buildings in climates with a moderate to high incidence of sunny weather, which is the case for a significant part of California.

“Angular selective” shading systems block or filter direct sunlight and admit reflected sunlight, diffuse skylight, or ground-reflected daylight within a specific range of incident solar angles. They can be as broadly applicable as non-angular-selective filters, such as diffusing glass, but have the potential to deliver more optimal energy-efficient performance within the typical 4.6 m (15 ft) deep perimeter zone of buildings when tailored to a specific façade orientation and latitude. Angular selective systems can be made in a wide variety of shapes, sizes, materials, colors, and finishes. They are located either on the outdoor exterior face of windows (Figure 25) or as a between-pane layer in an insulating glass unit (IGU). Commercially available products include simple woven metal insect screens, punched metal screens, as well as more engineered systems like between-pane micro-louvered metal screens, high-reflectance sculpted meshes, and mirrored louver systems.

**Figure 25: Exterior view of LBNL Advanced Windows Testbed with exterior shading systems**



Source: LBNL.

According to the 2006 California Commercial End-Use Survey (Itron 2006), not only does cooling represent 15 percent of the electricity use in California commercial buildings, it is also the largest end-use component during periods of peak electric consumption—hot summer afternoons. Reducing cooling energy and peak electric demand are among the top reasons that the California building energy code, Title 24, has lowered the maximum allowable Relative Solar Heat Gain Coefficient (RSHGC) significantly in the prescriptive requirements of its 2013 revision. The 2008 code prescribed RSHGC values for nonresidential buildings ranged from 0.31 to 0.72, depending on window-to-wall ratio, orientation, and climate zone. The 2013 maximum RSHGC is only differentiated by window type: 0.26 is the maximum allowed RSHGC for fixed windows, 0.22 for operable windows, and 0.26 for curtain walls and storefronts. Angular-selective shading systems have the potential to reduce cooling energy and peak demand savings while also enabling further lighting energy savings from daylighting by reducing the need to use operable interior shades.

If the angular selective system is a fixed, static building component, the technology is more likely to be incorporated in the Title 24 code, since it will deliver reliable energy savings. Between-pane systems are particularly well suited to this criteria and have the added advantage of requiring minimal cleaning or other maintenance. There are operable angular selective shading systems. Coplanar systems with a fixed angular selective shading layer such as a metal mesh can be raised and lowered manually by hand or with a motor, or automatically with a control system.

Specific technical objectives for this project were to identify technologies and strategies that enable a reduction in annual energy use at the perimeter zone of 30-50 percent below Title 24 2008 requirements while maintaining or even improving occupant comfort and amenity. When using low-energy cooling systems such as radiant cooling and natural ventilation, a maximum 4W/ft<sup>2</sup>-floor is desirable to ensure that comfort conditions are met (McConahey 2008). This was also set as a performance objective. Specific market objectives were to increase awareness of the value proposition of such technologies through third-party data, availability of modeling tools, and case studies.

To accomplish these objectives, the technical approach was similar to that described in Chapter 2. Modeling tools were first developed in order to assess the energy performance of the optically complex fenestration systems relative to conventional windows. This work extended the initial models that were developed for daylighting in Chapter 2 to include window heat gains. Measurement capabilities were developed to characterize the thermal heat transfer properties of the various materials and systems that were modeled in this study. The energy- and comfort-related performance of several commercially available, angular-selective shading systems was evaluated, then technology R&D was conducted to improve the performance of several of these systems in collaboration with industry. The virtual prototyping tool developed for daylighting systems (see Section 2.2.4) was further developed to include HVAC energy use as a performance objective and applied to selected systems to demonstrate its capability to identify optimal solutions more rapidly.

## 3.2 Modeling Optically Complex Fenestration Systems

### 3.2.1 Overview

Simulation tools are critically needed to evaluate the energy-efficiency performance of existing optically complex shading systems and to develop new products using an iterative design-evaluate process. The task of incorporating the daylight and window heat gain models for optically complex fenestration systems has been in the works for over a decade and delayed due to limited funding prior to 2010. Modifying EnergyPlus is a daunting task and requires detailed planning and careful work to incorporate new algorithms that both accommodate all potential variations on its use without inadvertently introducing new bugs. Because the official EnergyPlus code modification was scheduled to be completed at the end of this project (2013) by the EnergyPlus development team, who were working independent of this project, a work-around, Radiance-based solution was developed starting in 2010 to implement the window heat gain modeling capabilities for CFS that were needed to conduct this project.

The methods for measuring and modeling the daylight performance of optically complex fenestration systems are described in detail in Chapter 2. The approach for determining solar-optical portion of window heat gains is largely the same: Radiance algorithms for determining the distribution of transmitted solar radiation on indoor room surfaces and on the window system's shading and glazing layers are similar to those used for the daylighting algorithms.<sup>8</sup> Once these quantities are determined, the room and window heat balance are solved for each timestep in an annual calculation using EnergyPlus. Determining the absorbed solar radiation in each glazing or shading layer of the window system requires proper modeling of the subsequent radiative, conductive, and convective heat gains, and is handled using heat transfer algorithms that have been tailored to the unique physical configuration of the system (primarily for convective heat flow). These algorithms are developed for each "class" of systems and validated using measured data.

In the following sections, we describe the modeling approach for this work-around solution and the supporting measurements needed to characterize the thermal performance of optically complex systems.

### 3.2.2 Modeling Approach

For conventional window systems modeled by EnergyPlus, transmitted shortwave solar radiation is determined by a product of solar intensity and the transmittance coefficient of the window system. The distribution of the transmitted shortwave solar radiation is assumed to be uniform over an entire zone surface, with the percentage of the total transmitted radiation distributed in a prescribed manner to the zone surfaces. EnergyPlus has several methods for distributing this radiation, with the simplest method assigning all transmitted beam solar to the floor and the more elaborate method calculating beam radiation falling on each surface in the zone by projecting the sun's rays through the exterior windows, taking into account the effect of

---

<sup>8</sup> Unlike the daylighting calculations, the issue of high- or variable-resolution bidirectional scattering distribution function (BSDF) datasets, which is critical for modeling discomfort glare, is not relevant for solar heat gains: Klems determined that the solid angles defined by the 145 x 145 basis led to sufficient accuracy (Klems 1994a).

exterior shadowing surfaces and window shading devices. Any solar reflected by the floor is added to the transmitted diffuse radiation, which is assumed to be uniformly distributed on all interior surfaces. Long-wave radiative exchanges between the window and other room surfaces are addressed in the window heat balance calculation, where the indoor surface temperature of the window is determined.

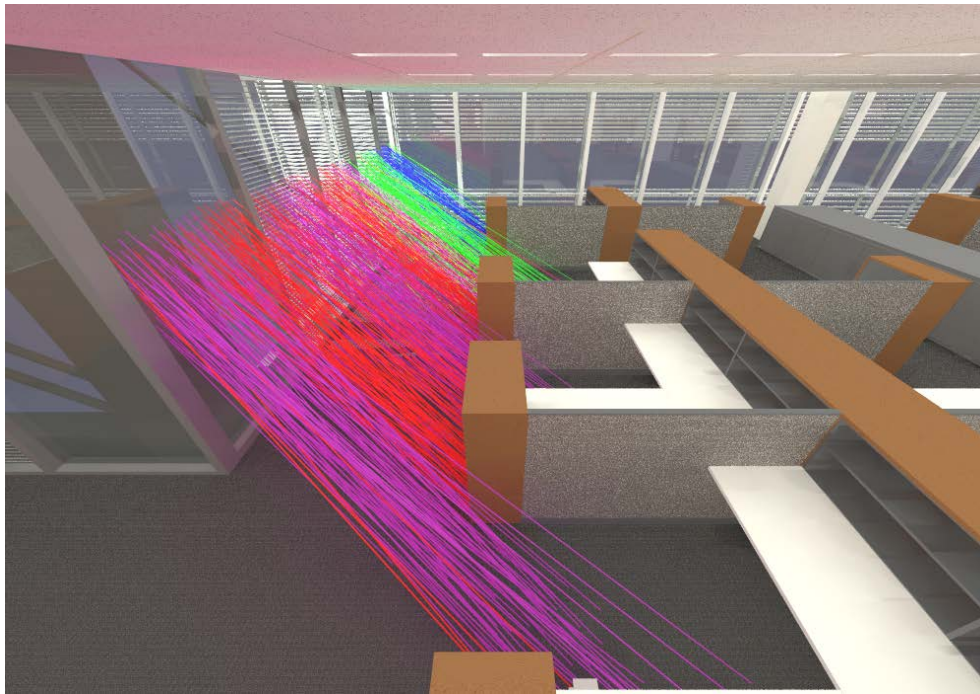
Accurate spatial modeling of radiation from windows can be critical in the evaluation of low-energy cooling systems and thermal discomfort. For example, shortwave radiation redirected toward the ceiling by a mirrored light shelf can affect the performance of radiant ceiling panels. The Radiance-based method implemented for this project accommodates the spatial distribution of radiation on indoor surfaces and is therefore potentially more accurate than the official version (based on view factors) that was released with EnergyPlus 8.0 in 2013. Updates to the daylighting algorithms in EnergyPlus (scheduled for release in 2014) will use BSDF data with the conventional split-flux method to accommodate optically complex systems as an interim solution. For this study, Radiance was used to model both the window heat gain and daylighting performance of an optically complex system, ensuring greater consistency in the modeling approach. This Radiance-based method was incorporated into the EnergyPlus 8.1 release but requires that end users know how to use Radiance.

The Radiance-based method consists of two steps. First, the following quantities are determined outside of EnergyPlus for each timestep: (1) the amount of transmitted shortwave radiation on each interior zone surface and the furniture surfaces of each thermal zone using Radiance (Figure 26), and (2) the amount of solar radiation absorbed in each layer of the window system taking into account the effects of shading by adjacent outdoor surfaces and nearby buildings, as well as the reflection of diffuse sky radiation using Radiance and a modified version of WINDOW 6 that incorporates the Klems matrix calculation method described in Section 2.2.1.1. Second, EnergyPlus Schedule objects are used to overwrite the corresponding quantities in a modified version of EnergyPlus during run-time. The window and zone heat balance calculations are then conducted using the conventional EnergyPlus algorithms. The method is described in greater detail in (Nouidui et al. 2011).

Further refinements to EnergyPlus were developed over the term of the project to accommodate multiple shading layers and operable shading layers. Prior to EnergyPlus 8.1, only one shading layer was permitted within EnergyPlus. For façade systems involving multiple coplanar shading layers, the additional shading layers were modeled as a glazing layer, and material properties were adjusted to match that of the shading layer. Convective heat flow within the shading layer, such as a perforated fabric material or a louver system with lateral openings, was not modeled. With EnergyPlus 8.1, this interim approach was disbanded and the thermal models were extended to allow for multiple shading layers with convective heat flows both around and through the shading layers.



**Figure 26: Transmitted solar radiation on indoor room surfaces**

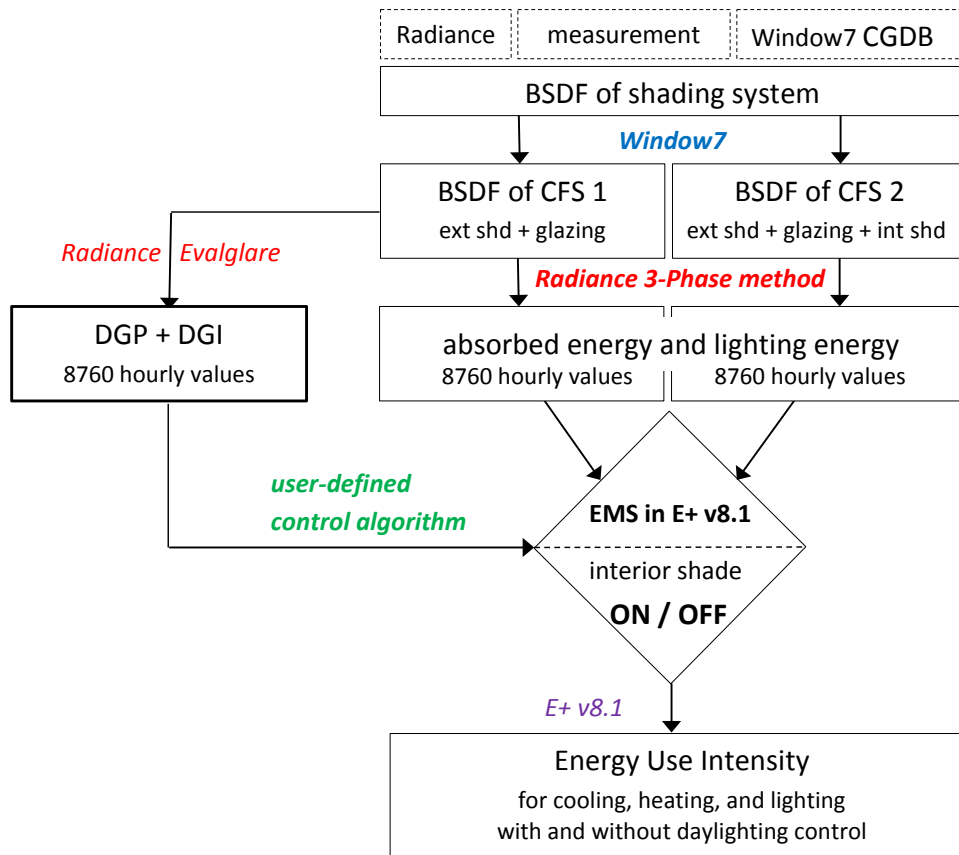


One of the first tests of this Radiance extension method was in the modeling of the energy performance of one floor of The New York Times Building. This building has fixed exterior shading and automated interior shading, and therefore the solar-optical characteristics of the windows are not only optically complex, but can also change between timesteps. This figure shows how rays, traced in Radiance from the windows, can be accounted for according to the surface on which they fall. Rays that fall on the perimeter zone floor are colored green. Rays that fall on the furniture in the perimeter zone are colored blue. Rays that fall on the core zone floor are colored magenta. Rays that fall on the furniture in the core zone are colored red.

Source: Lee et al. 2012.

For operable shading systems, prior to EnergyPlus 7.1, the end user had to determine the control mode of the shade outside of EnergyPlus and then construct the Radiance-based schedules associated with window heat gains and daylighting for use in the timestep calculations within EnergyPlus. This method was used in the analysis of The New York Times building (see Section 4.4.2) using schedules of shade control mode from the manufacturer. With EnergyPlus 7.1, the energy management system (EMS) tool was expanded to allow end users to actuate a wide variety of controllable devices, including shading layers, based on a user-defined control algorithm. To use the Radiance-based method for modeling CFS, scheduled values (absorbed radiation per window layer, transmitted solar, and lighting energy) are determined using Radiance for each state of the shading device (e.g., 10 slat angles with the shade fully lowered and the shade fully raised). Then in the timestep calculation, the EMS module within EnergyPlus determines the state of the shading device based on the user-defined control algorithm, which then selects the correct set of Radiance schedules for the calculation of window and room heat balance and total perimeter zone energy use (Figure 27).

**Figure 27: EnergyPlus workflow for modeling operable shading systems**



Source: Hoffmann and Lee 2014.

Thermal heat transfer algorithms for window systems were updated within EnergyPlus. Prior to EnergyPlus 7.2, algorithms defined by the ISO 15099 Standard were used to determine thermal heat transfer due to conduction, convection, and long-wave radiation through the fenestration system. The new implementation also adheres to the International Organization for Standardization (ISO) 15099 Standard, but there were differences in the numerical solution between the two implementations. For example, the pre-7.2 implementation does not allow for between-pane shading layers to be placed asymmetrically within the air cavity, while the version-7.2 implementation via WINDOW 7 does. Testing and debugging revealed some inconsistencies between the implementations, and these inconsistencies were eliminated.

When the view-factor based or “Klems” implementation of the CFS method was implemented and officially released in EnergyPlus (version 7.2), all end users had the ability to more accurately model the window heat gains resulting from light-scattering, optically complex fenestration systems. The end user constructs the window system and shading layer within WINDOW 7, then generates a BSDF output file for use by EnergyPlus. Comparisons were made between the Klems and Radiance-based calculation methods, and the window heat gains were found to be comparable.

The tools development work in this project occurred at the same time as the technology R&D. The analysis of various shading systems in Section 3.3 were conducted over the term of this project. Different versions of EnergyPlus, prototype reference models, and climates were used as new modeling capabilities were added by the LBNL and EnergyPlus teams and new energy-efficiency codes and standards were issued. While the Radiance solar-optical models remained the same between the various studies, the thermal models evolved as limitations and bugs were identified and resolved. The HVAC models were also being debugged by the EnergyPlus team, which caused considerable delay in the analysis of the technologies.

### 3.2.3 Thermal Measurements

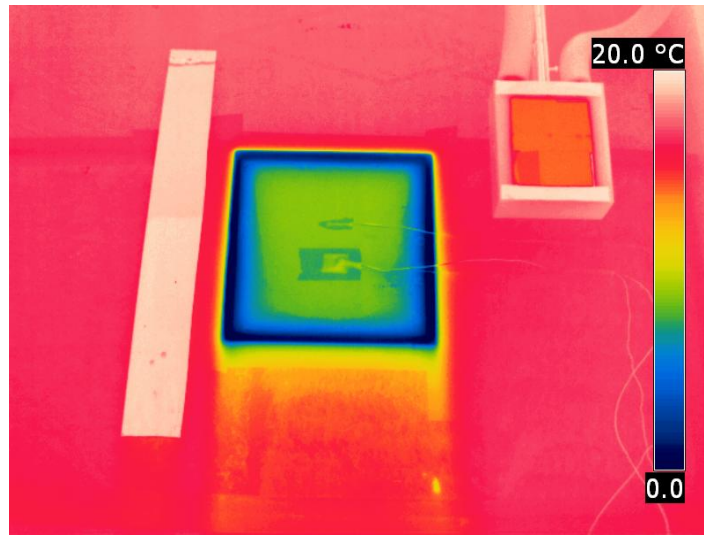
Because there are many different shading types and literally thousands of variations of color, materials, and geometry for a given shade type, thermal heat transfer models were developed for specific classes of product (e.g., louvered blinds, cellular shades, fabric shades, shutters) based on heat transfer physics, then validated by direct measurement of a representative sample within the product class. When the end user then specifies the shading layer in WINDOW 7, details concerning the geometry and material properties are required for input in order to generate the proper heat transfer coefficients used by EnergyPlus in the window heat gain calculation. When using WINDOW, it is important that the end user select the appropriate model and use it for the particular context for which the model has been developed (e.g., cellular shade in a vertical, indoor position; fabric shade in a horizontal between-pane position).

For purposes of model validation, heat transfer measurement techniques proven in the evaluation of simple specular glazing systems are applicable to CFS, although more attention to local performance details may be necessary to characterize and accurately model CFS products. The primary measurement techniques used by LBNL for validation of thermal models include: calorimetric environmental climate chambers, infrared thermography surface temperature measurement, flat plate conductivity (American Society for Testing and Materials (ASTM) C518-compliant) instruments, thin-film heat flux sensors, and air velocity probes.

*Calorimetric environmental climate chambers* are the commercial standard for U-factor measurement of fenestration. Solar calorimeters likewise measure the solar heat gain coefficient (SHGC) of fenestration exposed to solar radiation. These are important tools to validate the whole product performance, which is the labeled rating reported for fenestration products; however, these apparatus report a single average value over the whole product with no detailed information regarding the performance distribution, which can be a valuable aid to model development and validation.

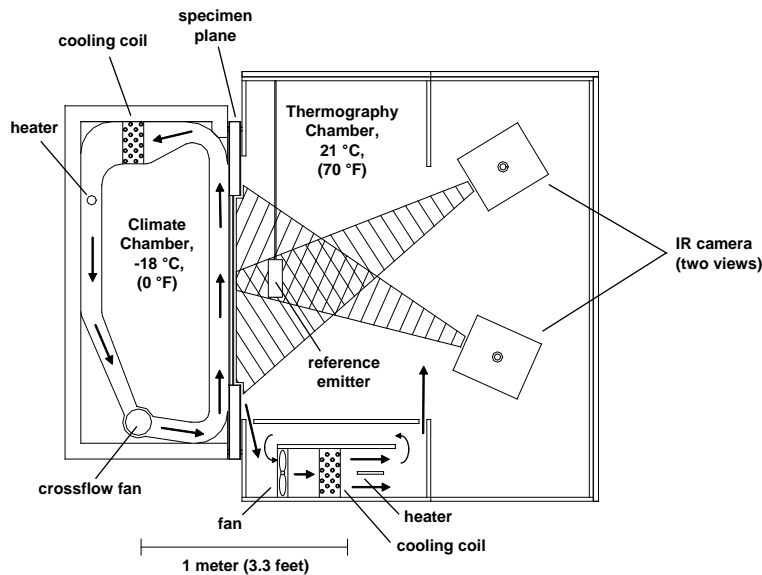
Using *infrared thermography* (Figures 28 and 29) under the same well-controlled laboratory test conditions used in calorimetry, it is possible to generate high-resolution surface temperature data, providing a quantitative temperature for each pixel in the image. This technique provides many more points of comparison between physical measurements and thermal models, allowing for a detailed evaluation of the model over different regions of the product. Careful external referencing and correction for thermal emittance and background radiation reflection are necessary to achieve accurate quantitative infrared thermography surface temperatures.

**Figure 28: Infrared image of angular selective between glass shading system with a thin film surface heat flux sensor near the center of glass**



Source: LBNL.

**Figure 29: Infrared thermography apparatus**



Source: LBNL.

*Flat plate heat transfer instruments* are typically used to measure material conductivity (ASTM C518), but these instruments can also be used to determine material properties as well as measure the thermal performance of some complex fenestration assemblies, especially those with small-scaled structures between glass. These instruments are typically smaller than environmental chambers which can measure complete building-scale fenestration products; however, if the glazing system contains between-glass features with repeated non-uniformities

of smaller structure than the metering area of the instrument, it is possible to measure the center-of-glass thermal properties of a complex system. It is important that samples containing air cavities are oriented such that gravity acts in the designed direction relative to the sample, to allow measurement of the correct convection behavior (this may require rotation of the entire instrument). A conductivity apparatus is typically used for measuring heat transfer in solids (conductivity only) without convection and radiation. However, assemblies with air cavities will include convection and radiation heat transfer in the reported conductance of the system. Because of the smaller size of samples in typical conductivity apparatus, it is important that samples have relatively sealed air cavities of the same size in actual installations. A large open convective loop in a large glass unit will not have the same heat transfer as a smaller sample unless the convective pattern is constrained to the same local constraints as in the smaller case.

To augment measurements made using infrared thermography or a calorimeter chamber, it is also useful to include thin film heat flux transducers to meter local heat flux. Because infrared thermography surface temperature measurements do not directly provide a measurement of U-factor, determining heat flux in particular locations provides additional points of comparison to thermal models, and measurement of both temperature and heat flux allow a local U-factor to be calculated. Likewise, in whole product calorimetry chambers, a local thin film heat flux sensor can provide local performance information to help refine models during the validation process and/or help isolate glazing performance from frame performance. Complex fenestration systems often involve geometries that complicate the convective air flows that are important for heat transfer. Measurements of air velocities near a window (specifically the open slots surrounding a loose-fitting shading system, for example) provide valuable information to aid model development.

Direct thermal measurement methods are time consuming and incompatible with the goal of rating the large number of product variations and combinations on the market. In some specialized cases, a thermal measurement may be necessary to characterize a product that does not yet have an adequate thermal model describing its behavior. These products can be measured in commercial calorimeters for both U-factor and SHGC. A rating system for optically complex fenestration systems may require physical testing of a representative sample of products, but the number tested this way is expected to be relatively low.

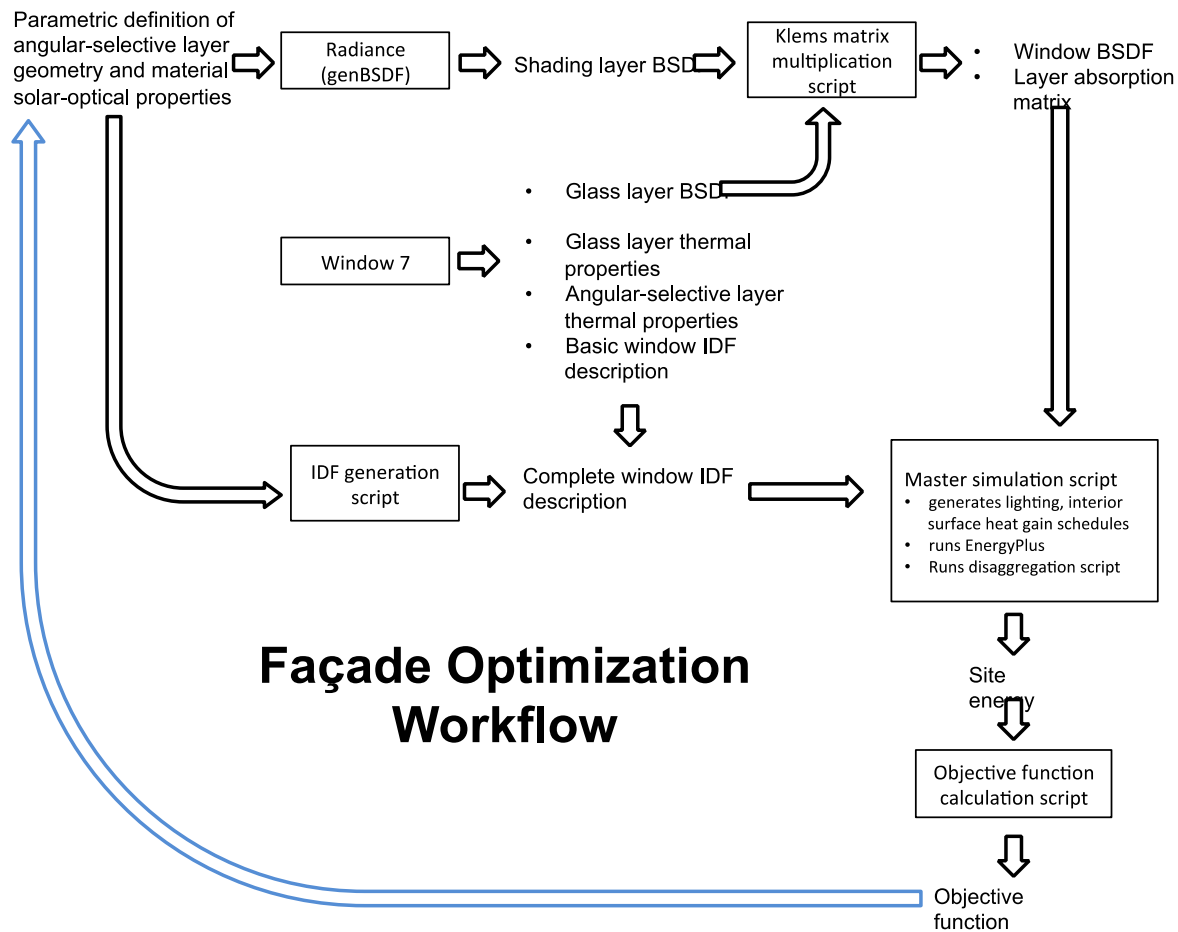
### 3.2.4 Virtual Prototyping Using Optimization Software

The virtual prototyping tool described in Section 2.2.4 was extended to enable minimization of annual energy use to be included as the performance objective. Solving this problem within reasonable time constraints with high-fidelity Radiance and EnergyPlus models was challenging enough so the focus of development activities was on energy minimization; comfort constraints were not included in this initial implementation.

Figure 30 illustrates the workflow that was built in order to automate the derivation of optimal solar control solutions through iterative design. Like the tool for developing daylighting technologies, the shade's geometric and material's solar-optical properties were first parameterized (upper left-hand corner of the diagram) then fed as inputs to generate BSDF datasets using the Radiance genBSDF tool for the shading layer. Prior to the parametric

modeling, the full window system—consisting of glass, coatings, gas fill, and shading layers—is defined by hand in WINDOW 7 to determine the thermal properties needed as input into EnergyPlus.

**Figure 30: Iterative process for generating improved angular-selective shading systems**



Source: Fernandes et al. 2014.

For the parametric runs, the shading layer BSDF is then combined with the glass layer BSDFs from the WINDOW 7 run, and then the Klems matrix algorithms are used to produce the window system transmission and absorption layer matrices. The Klems matrix calculation was replicated from WINDOW as a separate subroutine so that the parametric analysis could be conducted automatically. These data are fed into the master simulation script, which produces the various input schedules needed to determine window heat gain and lighting energy use. EnergyPlus is then run, producing annual energy use for each perimeter zone using a disaggregation script which splits whole-building energy use into the respective zones. The objective function then determines whether the design resulted in lower energy use, and this information is used to set the parameters for the next run. Rapid convergence toward an optimum solution is achieved using a pattern search method.



The tool was applied to improve the performance of an existing shading system. This work is discussed in Section 3.3.2.

### 3.3 Technology R&D

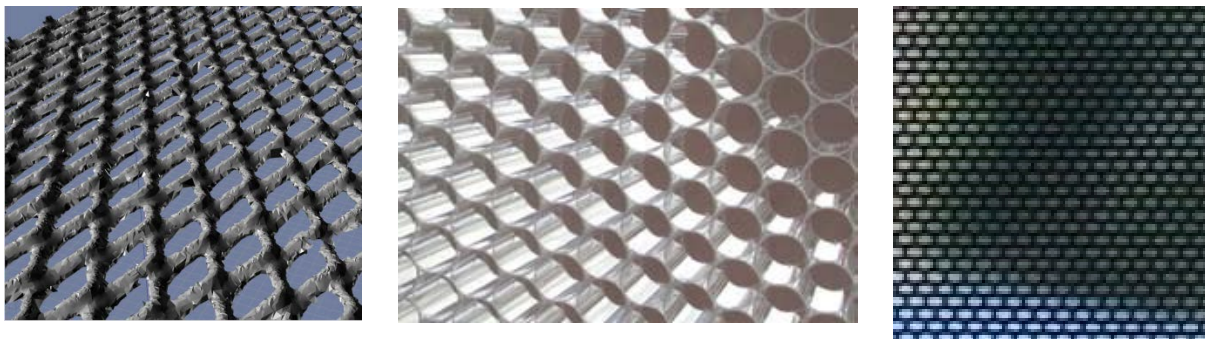
#### 3.3.1 Commercially Available Between-pane Shading Systems

##### *Approach and Goals*

Between-pane, static, or non-operable angular-selective shading systems have the advantage of being protected from the elements by at least one pane of glass. This means higher potential durability and also obviates the need for cleaning. One drawback is lower effectiveness in rejecting solar heat gains, and therefore lower energy- efficiency potential compared to outdoor exterior shading systems. However, exterior shading systems must be designed to withstand the weather (wind loads, ice, etc.) and other outdoor elements (corrosive marine air, dirt, birds, etc.). Between-pane systems are most applicable for new construction or major renovations, and therefore have less broad market applicability than interior shading attachments due to their greater installation cost for the existing buildings market. Another drawback of the shading layer being static is that it permanently obscures the view to greater or lesser degrees, depending on the design. To address this drawback, the systems investigated in this study are often used in combination with unobstructed view windows.

An initial investigation was conducted to determine the energy-savings potential of three commercially available, static, angular selective shading systems in the perimeter zones of a typical large commercial office building. The initial focus of the study was to determine the relative performance of different types of angular selective shading layers positioned either as an outdoor shade or a between-pane shading layer, but the thermal properties of the window assembly was quickly found to play an equal role in determining performance as the solar-optical properties. The focus shifted to investigating the overall performance of the window and shading assembly rather than just the shading layer.

**Figure 31: Three commercially available angular selective shading systems**



Left: expanded metal mesh. Middle: tubular shading structure. Right: microperforated screen.

Source: LBNL.

## *Outcomes*

Three systems were selected that were either popular with architects for aesthetic reasons or that appeared to have the potential for significant energy savings (Figure 31). The first system (designated as G1) consists of a thin, microperforated metal screen (Photosolar: MicroShade®) that is adhered to one of the interior surfaces within the cavity of a spectrally selective, low-emittance ( $e = 0.018$ ) insulating glass unit (IGU). When viewed from a distance, the screen permits a largely unobstructed, undistorted view of the outdoors for a wide range of horizontal viewing angles within 1–2 m from the window. The second system consists of short, plastic tubes that are stacked within the cavity of an IGU (Panelite: ClearShade™). We studied dual- and triple-pane windows with this system. The dual-pane IGU (H1) has a less effective pyrolytic low-emittance coating ( $e = 0.215$ ) because the ends of the tubes are in direct contact with the glazing surfaces. The triple-pane configuration (H1T) has the tubular shading layer in the outboard (near exterior) air cavity, and two spectrally selective, low-emittance ( $e = 0.018$ ) coatings on the inner surfaces of the inboard air cavity. Depending on the length and diameter of the tubes, direct unobstructed view is possible only when the eye is aligned with the longitudinal axis of the tube. The third system (I1) is an expanded metal mesh with a highly reflective aluminum finish placed between two layers of glass with a third inboard spectrally selective, low-emittance ( $e = 0.018$ ) glazing layer to form a triple-pane unit (Schott North America: OKATECH™). The mesh partially obscured direct views out and is best viewed at a distance of 5–10 m to resolve views to the outdoors.

A parametric analysis was conducted using the Radiance-based method in EnergyPlus of a large prototypical office building with and without daylighting controls, where window-to-wall area ratio (WWR) was varied from 0.15–0.60. Savings varied substantially according to climate, orientation, window-to-wall ratio, angular selective window, and presence of daylighting controls. Overall, results indicated significant technical potential. If properly engineered, between pane shading systems could meet the overall performance objective of this project (i.e., reduce perimeter zone energy use by 20-30 percent below Title 24 2008).

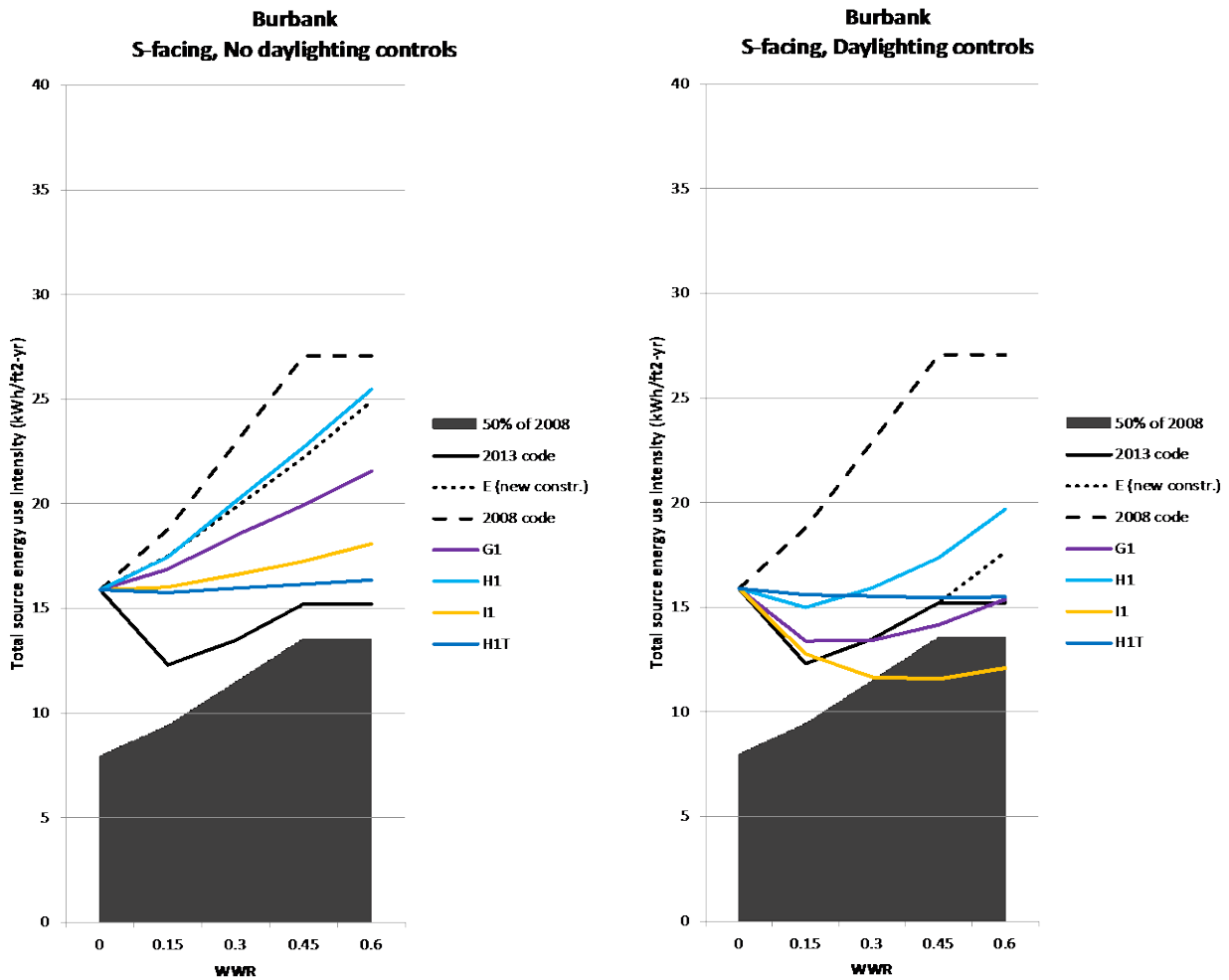
For example, the between pane shading system with sputtered low emittance coatings in combination with the tubular shading layer (H1T) reduced total annual source energy use (through reductions in HVAC energy use) by 16-40 percent compared to Title 24 2008 code for south-, east-, and west-facing perimeter zones of a prototypical large office building in Burbank, California with small to large area windows (WWR between 0.15-0.60). In comparison, the same system with pyrolytic low-e coatings (H1) performed far worse with almost the same energy use as an unshaded, advanced spectrally selective low-e window (Figure 32). In conclusion, systems that did not increase the insulating glass unit's thermal conductance and inward flowing fraction of radiative heat gains did particularly well.

Compared to Title 24 2013 levels which now mandates use of automated daylighting controls in the perimeter zone, the between pane shading with expanded metal mesh (I1) reduced total annual source energy use by 14-24 percent for WWR between 0.30-0.60. Here, the system had both the advantage of angular selective solar control and enhanced daylight admission given its reflective metal mesh system (Figure 33). In absolute terms, total source energy use intensity



levels for these systems were well below the project’s 30 percent goal: the I1 system with daylighting controls resulted in 32-55 percent savings relative to the Title 24 2008 code or 11.6-12.8 kWh/ft<sup>2</sup>-yr (12-16 kBtu/ft<sup>2</sup>-yr site).

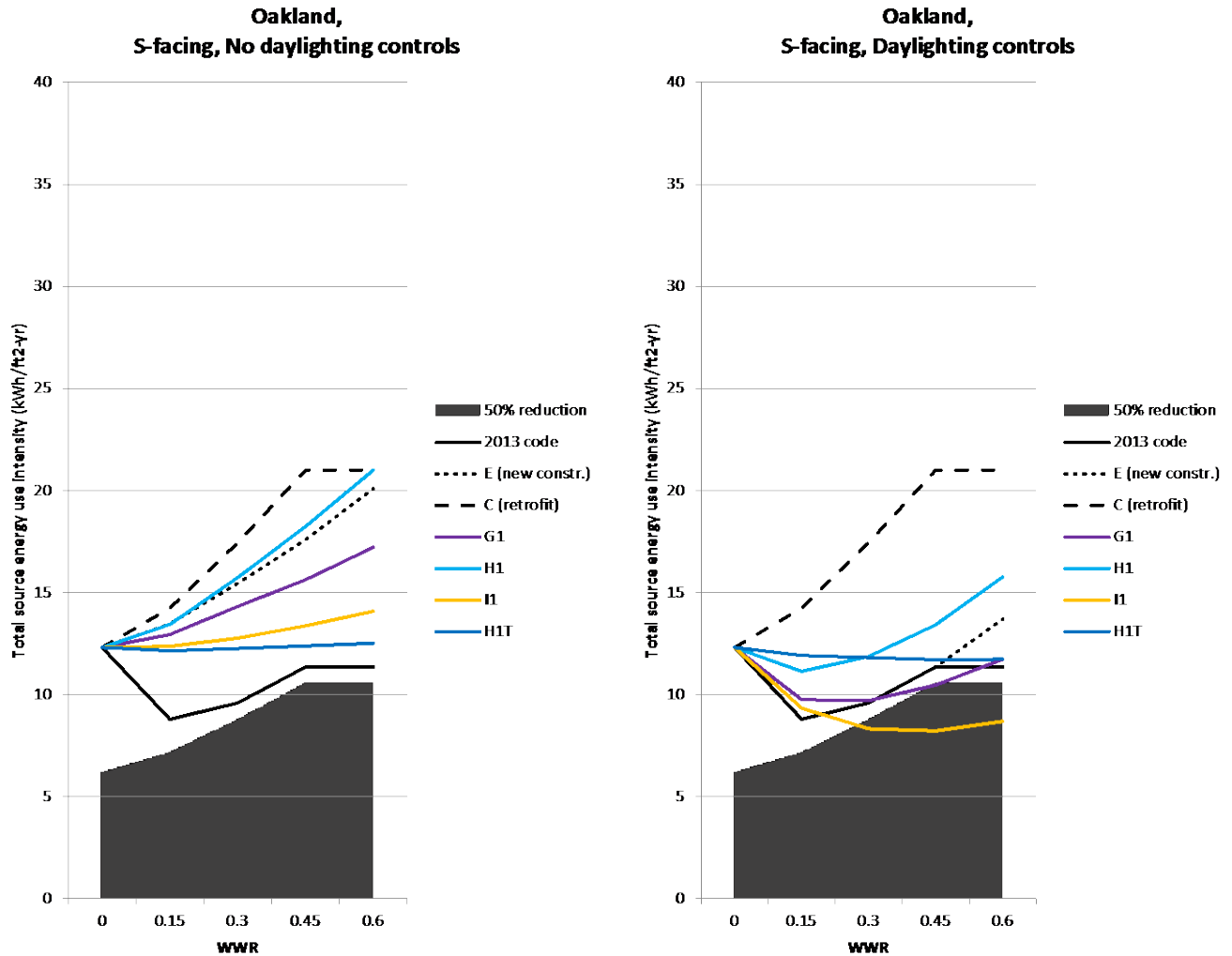
**Figure 32: Total annual source energy use intensity in south-facing perimeter zones of a typical large office building using angular selective shading systems for Burbank, California**



The black solid and dashed lines (labeled 2013 code and 2008 code) denotes the performance of an unshaded window that meets the Title 24 2013 and 2008 codes. The dotted line (labeled E new construction) shows the performance of an unshaded high-performance window with an advanced low-e coating. The colored lines (labeled G1, H1, H1T, and I1) show the performance of the microperforated screen, two- and three-paned tubular shading structure, and expanded metal mesh systems, respectively. The top edge of the shaded area indicates 50 percent savings relative to the Title 24 2008 code.

Source: Fernandes et al. 2013.

Figure 33: Total annual source energy use intensity in south-facing perimeter zones of a typical large office building using angular selective shading systems for Oakland, California



The black solid and dashed lines (labeled 2013 code and 2008 code) denotes the performance of an unshaded window that meets the Title 24 2013 and 2008 codes. The dotted line (labeled E new construction) shows the performance of an unshaded high-performance window with an advanced low-e coating. The colored lines (labeled G1, H1, H1T, and I1) show the performance of the microperforated screen, two- and three-paned tubular shading structure, and expanded metal mesh systems, respectively. The top edge of the shaded area indicates 50 percent savings relative to the Title 24 2008 code.

Source: Fernandes et al. 2013.

Peak window heat gains were also significantly reduced. The maximum 4 W/ft<sup>2</sup>-floor criterion was met for small- to moderate-area windows (WWR = 0.15-0.45) with the triple-pane, expanded metal mesh system. For smaller-area windows (WWR = 0.15–0.30) the criterion was met by the dual-pane, microperforated screen system, with the triple-paned configuration of the tubular shading device performing slightly better. For a south-facing window in Burbank



For the expanded metal mesh (I1), this is the case for 52 percent of the year (March 18 to September 24). During the rest of the year, the sun will not be shaded during parts of or the whole day. This greater openness, however, will allow less-obstructed views of the exterior.

Discomfort glare however is not only dependent on how and when the system occludes direct sun, but also how it mitigates sky glare, and whether the system itself produces glare as daylight filters through the shading material. Glare not addressed by the between pane shading layer will likely need to be controlled with a second indoor shade, which in turn will reduce HVAC energy use but increase lighting energy use. The ideal would be to identify between pane shading designs that provide an optimum balance between these performance parameters without the need for a second indoor shade.

This analysis was able to determine annual glare performance of the shading systems using Radiance (using the same viewpoints described in Section 2.2.5) but not the associated total energy use for an angular shading system with an indoor operable shade: EnergyPlus 8.1 was limited in this respect. The glare evaluation was conservative: electric lighting was not modeled so adaptation levels were poor when daylight levels in the space were low. Both the tubular shading system and microperforated screen resulted in 32-34 percent annual occurrence of discomfort glare ( $DGP > 0.38$ ) while the expanded metal mesh system resulted in 16 percent annual occurrence for a 40 ft deep south-facing perimeter zone in Burbank and Oakland. More detailed results can be found in Fernandes et al. 2013.

### 3.3.2 Virtual Prototyping of an Angular Selective Shading Layer

#### *Approach and Goals*

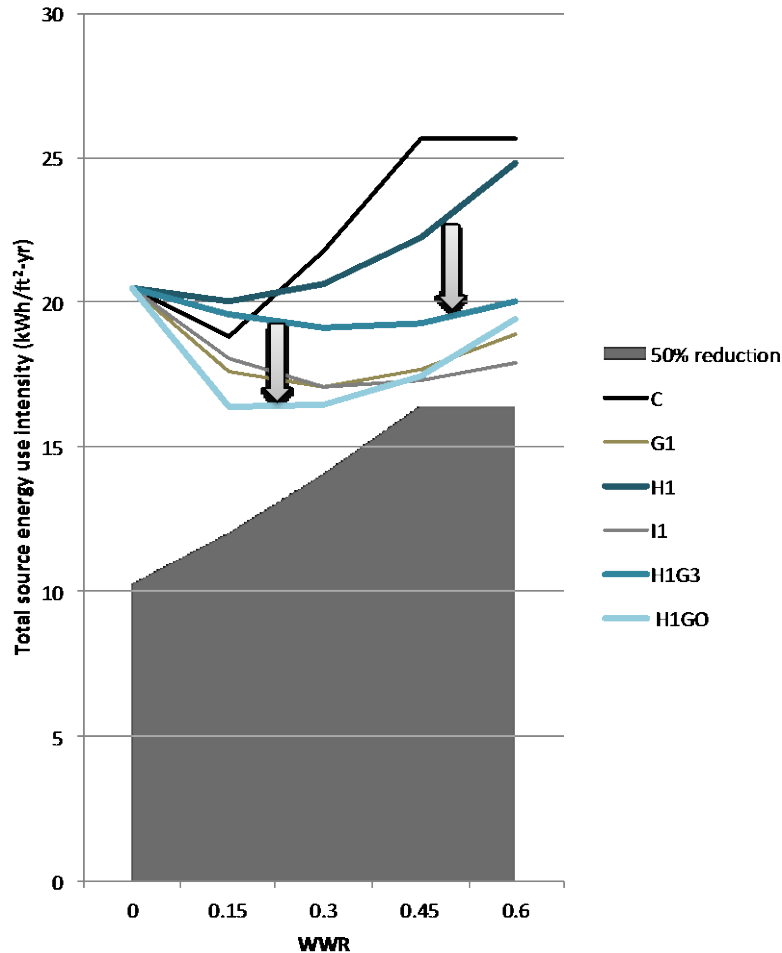
When we first characterized the performance of the three commercially available angular-selective shading systems discussed in Section 3.3.1, results showed that two of the systems performed significantly better than the third—the dual-pane tubular shading structure (H1) that was the manufacturer’s product offering at the time. Two main factors were apparent in this performance disparity. The first was that H1’s pyrolitic low-emittance coating had an emittance that was considerably greater than the sputtered coating so radiative heat gains due to absorbed radiation were considerably greater than the other two systems. The other, perhaps more subtle, was that although the tubular layer blocked some solar radiation, a significant fraction of that heat was being conducted to the building interior. Engineering expertise and the virtual prototyping tool described in Section 3.2.4 were used to improve performance.

#### *Outcomes*

Given the results of the initial analysis, two improvements were in order. The first was to reduce the thickness of the shading layer so that it did not touch one of the glazing surfaces within the IGU. This enabled the use of a spectrally selective low-e coating. A system was designed in which the tubular shading layer was scaled down so that it had a thickness of 3 mm (versus the prior 12.7 mm), while maintaining the same solar-optical properties. Results (see curve H1G3 in Figure 35) showed a significant improvement in performance (13 percent for  $WWR = 0.45$ ), approaching the levels achieved by the other two systems. The triple-pane

configuration was modeled as well (results given in Section 3.3.1), and the manufacturer subsequently offered the triple-pane system as a solution to clients.

**Figure 35: Improvements in the performance of an angular-selective shading system**



The arrows show improvements in the performance of an angle-selective shading system based on a tubular shading structure. The dark blue curve (labeled H1) is the original system. Simple heuristic improvements led to an improved design (middle-blue curve, labeled H1G3). Systematic optimization then led to a further improved design (light blue curve, labeled H1GO).

Source: Fernandes et al. 2013.

Second, we then applied the optimization process described in Section 3.2.4 to optimize the design of the shading layer. A parametric description of the geometry and optical properties of the angular-selective layer was developed in which tube height, diameter, transmittance, and specularity were defined as the independent variables. The tool was run with all the possible combinations of three values for each parameter: 1.27, 6.985, and 12.7 mm (0.05, 0.275, and 0.5 in.) for both tube height and diameter, and 0, 0.5, and 1 for both transmittance and

specularity coefficients. This amounted to a total of 81 parametric runs, which took approximately 24 hours to run on six 16-CPU-core nodes of a Linux supercomputing cluster.

The results from the parametric simulations were then used as a starting point for an optimization, using the Hooke-Jeeves generalized pattern search algorithm (Wetter 2011). After running for 72 hours, the algorithm found the most optimum combination of parameters. Results show a significant improvement in performance relative to the modifications determined heuristically, totaling 22 percent relative to the original system (see curve H1GO in Figure 35). Note that even though the system was optimized for WWR = 0.45 and daylighting controls, it still performs quite well for other window-to-wall ratios.

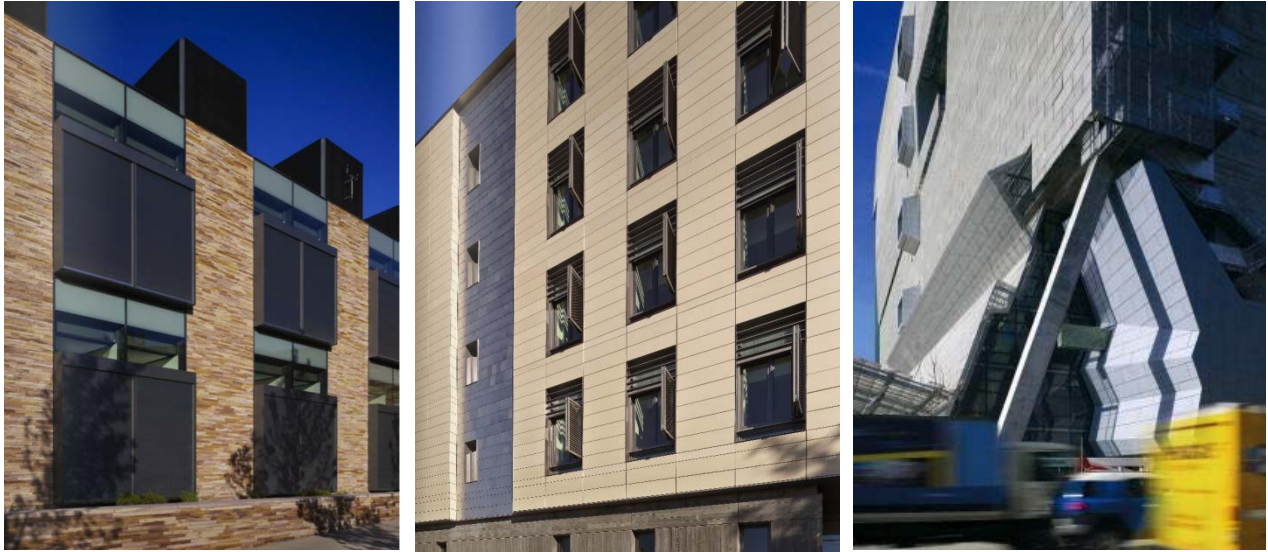
This limited study demonstrates the value of these powerful prototyping tools to accelerate the development of innovative, energy-efficiency technologies. More detailed results are given in (Fernandes and Lee 2013).

### 3.3.3 Exterior Shading Systems

#### *Approach and Goals*

Exterior shades (Figure 36) are reputed to be superior for solar control and can also be effective for daylighting and glare management, as was determined in Phase I of this project. A second simulation study was conducted to benchmark performance of this class of technologies against code and to determine which design parameters affect performance. This study was possible once the CFS-modeling capabilities, EMS, and multiple-shading layer algorithms needed to conduct such a study were developed and implemented in EnergyPlus 8.1. A prototypical, Title 24 2013 compliant, large office building was modeled where the window-to-wall ratio was varied from 0.15–0.60 with and without daylighting controls for the Burbank and Oakland, California climates.

**Figure 36: Photographs of buildings in California with exterior shades**

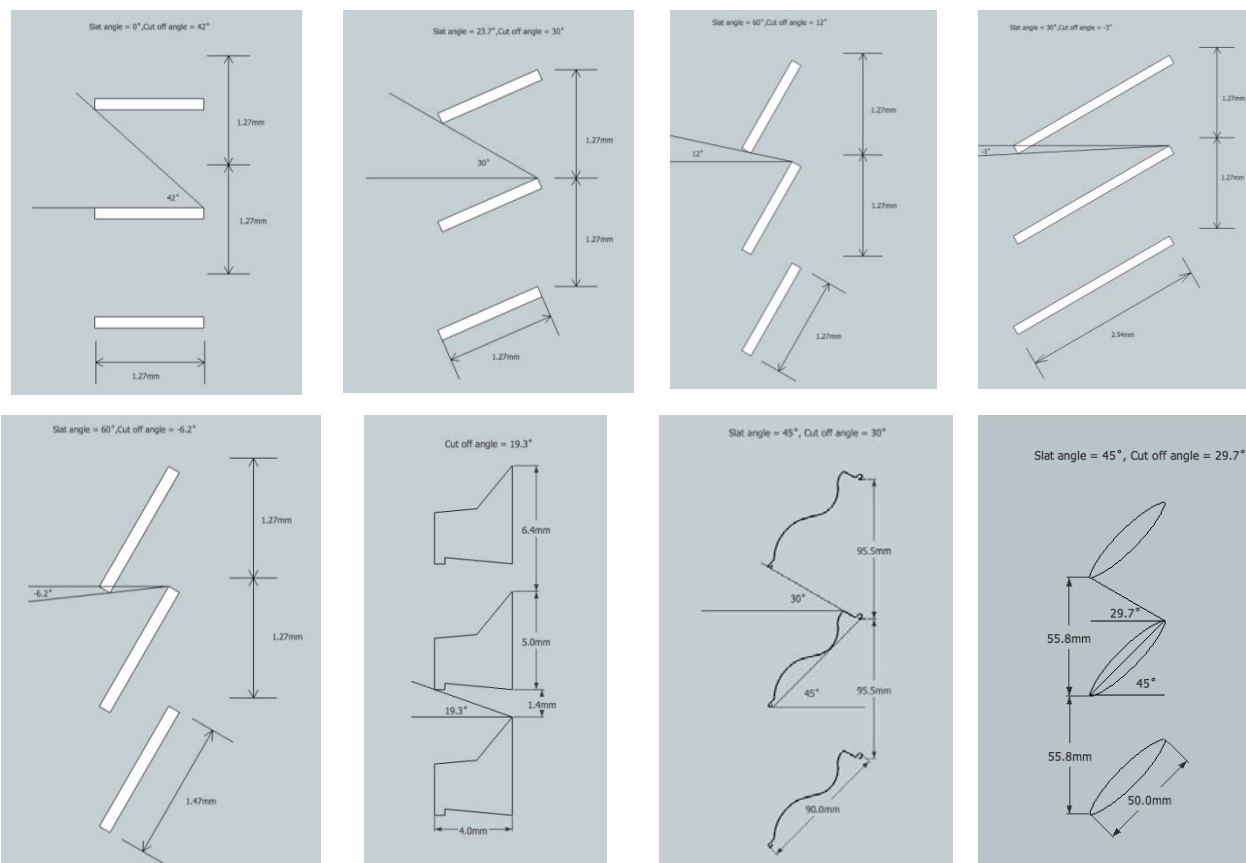


Left: Hilton Foundation, Agoura Hills, with stainless steel roller shades. Middle: Li Ka Shing, UC Berkeley, with aluminum louvers above the windows. Right: San Francisco Federal Building, with metal mesh.  
Source: LBNL.

### *Outcomes*

Eight static exterior shading systems were modeled (Figure 37). One of the first questions that was raised as a result of the Phase I study was whether there was a significant difference in annual energy use given variations in exterior shade type—particularly the cutoff angle of the shading system where direct sun is completely occluded by the shading system, preventing solar radiation from hitting the exterior face of the window. In the Phase I study, there was very little difference in net window heat flow between the various exterior shading systems measured in the LBNL Advanced Windows Testbed.

**Figure 37: Vertical profiles of eight exterior shading systems**



Left to right, upper row: micro slat shading screen with various cut off angles (shade [shd] 1-4); lower row: micro slat shading screen with -6.2° cut off angle (shd 5), slatted roller shade (s-enn, shd 6), slatted blind (Warema, shd 7c with medium solar reflectance), and aluminum louver system (shd 8).

Source: LBNL.

The cutoff angle of a simple, flat slat, metal screen (shd 1-5) was varied from 0°–45° (e.g., for solar profile angles less than 45°, direct solar transmission would occur; 0° provides total solar exclusion). For large-area windows (WWR = 0.60) in both Burbank and Oakland, annual energy use was largely insensitive to variations in cutoff angle below 30°—annual energy use varied by about 5 percent with absolute energy use levels approaching that of an opaque insulated wall. With daylighting controls, however, lighting energy use was increased significantly with increased solar occlusion. The optimum cutoff angle is therefore one that balances both solar control and daylighting objectives: a cutoff angle of 30° was optimum for this system for the south-, east-, and west-facing orientations in both Burbank and Oakland.

The solar reflectance ( $R_{sol}$ ) and visible reflectance ( $R_{vis}$ ) was varied ( $R_{sol} = 0.08–0.93$ ,  $R_{vis} = 0.15–0.87$ ) to determine how material properties affect performance. For a cutoff angle of 30° for a curved louvered system (shd 7), louvers with the greatest surface reflectance resulted in the lowest annual energy use because the reflectance increased daylighting while the louvers



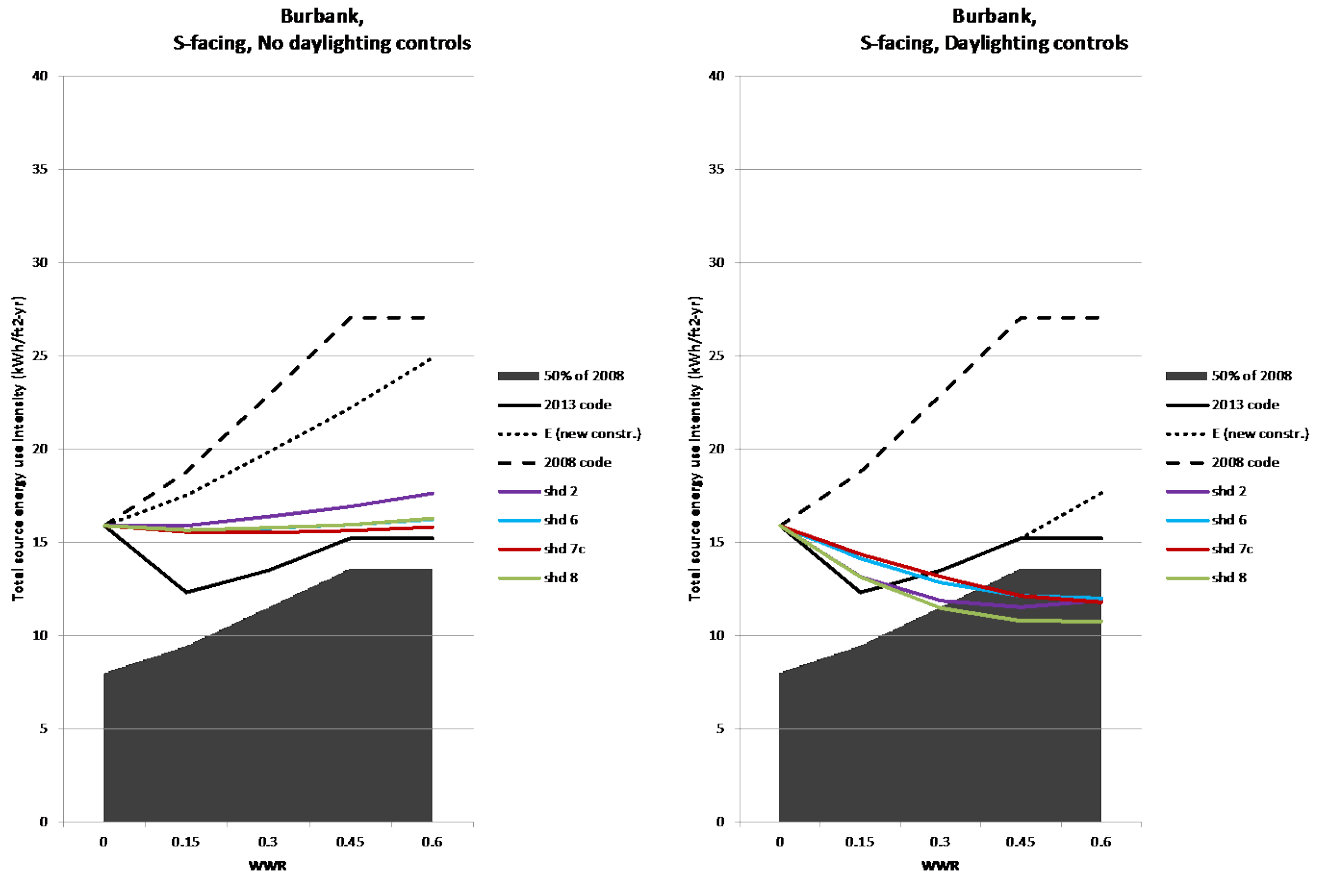
occluded direct sun. The increased diffuse radiation from the higher-reflectance shade produced a negligible effect on cooling energy use. In all practicality, however, a high visible reflectance may adversely affect glare, although dirt accumulation on the slats will likely temper this effect and negate the added improvement in energy performance. Note that the difference in annual energy use was at most 10 percent between the moderate ( $R_{vis} = 0.50$ ) and high reflectance ( $R_{vis} = 0.87$ ) systems for moderate-area ( $WWR = 0.30$ ) windows in mild climates (Oakland). Differences between systems for large-area windows in hot climates were greater, at most 18 percent.

Generally, total source annual energy use intensities were fairly insensitive to the type of exterior shading systems – unlike the between pane shading systems whose performance varied widely depending on details related to thermal heat gains. Variations in exterior shading performance were dictated by solar-optical performance: occlusion of direct sun and admission of diffuse daylight. Exterior shading reduced total annual source energy use (through reductions in HVAC energy use) by 17-42 percent compared to Title 24 2008 code for south-, east-, and west-facing perimeter zones of a prototypical large office building in Burbank, California with small to large area windows ( $WWR$  between 0.15-0.60, see Figure 38). Compared to Title 24 2013 levels which includes daylighting controls in the perimeter zone, exterior shading systems reduced annual source energy use by 15-30 percent for  $WWR$  between 0.30-0.60. Results for Oakland are shown in Figure 39.

Peak window heat gains were maintained well below the maximum 4 W/ft<sup>2</sup>-floor criterion set for this project for all systems ( $WWR = 0.15$ -0.60). For a south-facing window in Burbank ( $WWR=0.60$ ), a fixed slat screen (shd 2) reduced peak window heat gains by 78% compared to Title 24 2008 and 69% compared to the Title 24 2013.

The maximum annual occurrence of discomfort glare was 16 percent (shd 2 and shd 8) with some systems (shd 6 and shd 7c) resulting in no glare for a 40 ft deep south-facing perimeter zone in Burbank and Oakland. Additional details can be found in Hoffmann et al. (2014).

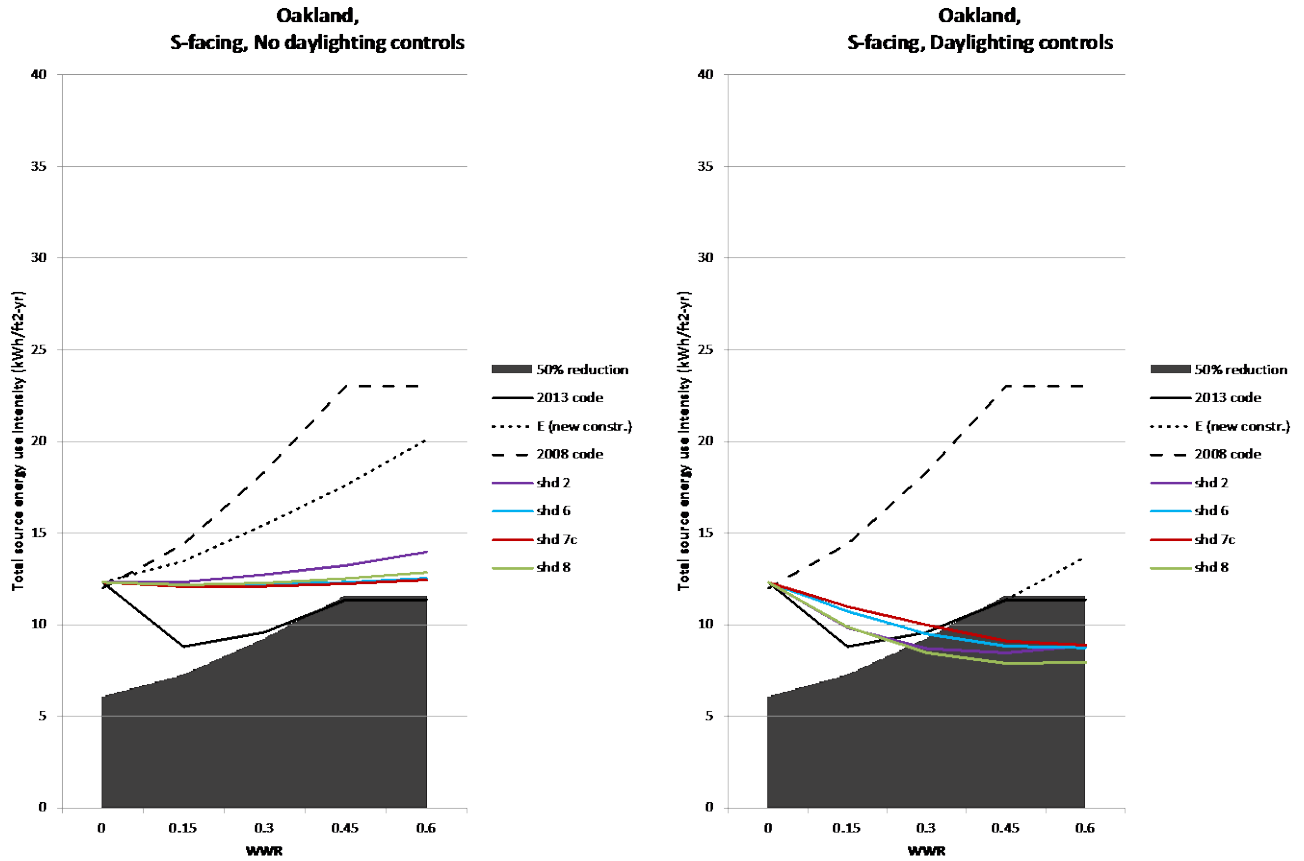
**Figure 38: Total annual source energy use intensity in south-facing perimeter zones of a typical large office building using commercially available exterior shading systems for Burbank climate**



The black solid and dashed lines (labeled 2013 code and 2008 code) denotes the performance of an unshaded window that meets the Title 24 2013 and 2008 codes. The dotted line (labeled E new construction) shows the performance of an unshaded high-performance window with an advanced low-coating. The colored lines (labeled shd 2, shd 6, shd 7c, and shd 8) show the performance of the micro slat shading screen, slatted roller shade, slatted blind, and louver system, respectively. The top edge of the shaded area indicates 50 percent savings relative to the Title 24 2008 code.

Source: LBNL.

**Figure 39: Total annual source energy use intensity in south-facing perimeter zones of a typical large office building using commercially available exterior shading systems for Oakland climate**



The black solid and dashed lines (labeled 2013 code and 2008 code) denotes the performance of an unshaded window that meets the Title 24 2013 and 2008 codes. The dotted line (labeled E new construction) shows the performance of an unshaded high-performance window with an advanced low-e coating. The colored lines (labeled shd 2, shd 6, shd 7c, and shd 8) show the performance of the micro slat shading screen, slatted roller shade, slatted blind, and louver system, respectively. The top edge of the shaded area indicates 50 percent savings relative to the Title 24 2008 code.

Source: LBNL.

### 3.4 Conclusions and Recommendations

#### 3.4.1 Conclusions

Both exterior and between pane shading systems with daylighting controls provide significant annual energy use reductions in south-, east-, and west-facing perimeter zones with moderate-to large-area windows (WWR = 0.30–0.60) in both the northern temperate and hot/dry southern climate zones in California compared to the Title 24 2008 (16-42 percent) and 2013 codes (14-30 percent), which mandates use of advanced low-e windows and daylighting controls. Both of these types of systems can be used to reduce peak cooling demand to levels where low-energy cooling strategies such as natural ventilation or radiant cooling can be used. If exterior shading

and advanced windows are combined with low-energy cooling strategies and daylighting controls, performance will achieve levels that enable zero net energy goals to be met.

The concept of “angular selectivity” implies that a particular combination of geometry and material properties can lead to an optimum balance between the goals of occluding direct sun (for both thermal and visual comfort), minimizing window net heat flow due to solar gains (for passive heating or cooling), maximizing useful daylight, and minimizing glare. Through the investigation of many types of systems and permuting both solar-optical and thermal parameters, annual energy use was found to vary significantly with between-pane shading systems but was somewhat insensitive with exterior shading systems. Details of thermal engineering mattered a great deal for between pane systems. Solar-optical performance dictated the differences in performance for exterior shading systems. A virtual prototyping tool was developed in this project and then demonstrated to show how the solar-optical properties of a between-pane shading layer could be optimized given properly engineered thermal details for the overall window system. Using this tool in partnership with industry could lead to the development of more optimal systems.

Performance relative to Title 24 code does not reflect actual building performance since the prescriptive code does not include indoor shades. For the between pane and exterior angular selective systems where direct solar occlusion is not achieved for a significant fraction of the year, indoor shades will likely be required to control thermal and visual discomfort, resulting in reduced lighting energy savings, but potentially a small increase in HVAC energy savings. The frequency of discomfort glare varied with the degree and method of solar occlusion, and shading material reflectance and transmission properties. Although not investigated in this study, thermal discomfort from temperature asymmetry from a hot, irradiated window wall or from direct solar radiation on occupants will be largely eliminated with either system if properly engineered (e.g., low-emittance coatings to prevent radiative heat transfer).

The quality of the view out is the primary concern for these types of systems. For this analysis, it was assumed that the exterior shading layer would be static, not raised and lowered seasonally, as is common with exterior shading systems used throughout the European Union. The shading could also be automatically controlled. Static systems “guarantee” energy savings, which is preferred by California utilities and energy standards, but end-user acceptance of the resultant indoor environment is unlikely if the view is significantly obscured by the shading system. Most manufacturers of these systems advocate use of separate unobstructed, small-area view windows. The portions of the window wall that use exterior or between-pane shading systems provide the added benefit of daylighting to perimeter zones, and can be used in combination with view windows.

Most exterior shading systems are limited in applicability to low- and mid-rise buildings of no more than about five stories tall due to wind loads. The systems need regular cleaning, particularly if the top of the surfaces can collect dirt and be seen by the occupant. They can accumulate snow and ice, so pedestrian safety should be considered for areas below the shading device. For retrofit applications in low-rise buildings, there are lightweight screens for moderate-area windows that can be clipped at the edge to the outside window frame at fairly

low cost, similar to an insect screen. These too need regular cleaning. For bulkier, heavier systems that could introduce shearing forces on the façade due to wind or gravity loading, a structural engineer may be needed to determine how the system can be connected to structural elements of the building. Between-pane systems have broader applicability and can be applied to most buildings, new or retrofit.

Both types of systems are most likely to be cost-effective in deep retrofits of pre-1990 buildings where the replacement of single-pane windows or dual-pane, dark-tinted windows is being considered by the facility manager. If combined with upgrades to the lighting (e.g., LEDs with daylighting controls) and HVAC upgrades, this integrated package could result in significantly lower perimeter zone energy use and synergistic cost reductions due to downsizing of the HVAC system (either chiller plant or VAV delivery systems).

### 3.4.2 Recommendations

It has long been known that exterior shading systems provide superior solar control compared to both between-pane and indoor shading systems. What may not be generally known is that with the proper thermal engineering and use of advanced spectrally selective, low-emittance coatings and glazing layers, between-pane shading systems can exert a comparable degree of solar control as exterior shading systems. For applications where control of perimeter zone loads is critical, it would be useful to encourage the development and deployment of between-pane, coplanar shading systems in internal load-dominated commercial buildings, particularly where low-energy cooling strategies such as natural ventilation or radiant cooling are being considered.

Energy-efficiency codes and standards are also exerting pressure to reduce window area as a simple prescriptive measure to reduce total energy use in buildings. Coplanar exterior and between pane shading systems offer an option to achieve lower annual energy use intensity with large-area windows than that of a smaller conventional window, particularly if daylighting is accounted for. Title 24 2013 has broadened the requirements for daylighting controls in buildings. It is recommended that the codes and standards integrate the requirements for electric lighting controls with additional requirements for fenestration systems based on both solar control and daylighting criteria (beyond just a simple requirement for minimum visible transmittance).

There are complex tradeoffs between solar control, daylighting, glare control, façade transparency, and view; and angular-selective shading systems can be designed to address all four considerations. It is recommended that when developing new technologies that the systems be optimized and evaluated based on these parameters. Glare, however, is by far the most difficult constraint and is highly dependent on the type of tasks being performed in the building, where the occupants' view is directed, what the surface finishes are, and other factors. Because windows are installed for the life of the building, it may be more practical to develop and promote technologies tailored for solar control, daylighting, and view, leaving glare management to the occupant's control.

Static coplanar shading systems may have limited market penetration because of their permanent impact on view. There are motorized exterior coplanar shading systems that can be automated or manually operated. These systems should also be supported for broad market deployment. Non-coplanar systems such as awnings, overhangs, and fins with optically complex properties were not evaluated because the modeling tools have not yet been developed to evaluate them: this work is underway and had not concluded at the end of this project.

Neither field tests nor monitored demonstrations of these technologies occurred in Phase II of this project: Phase I had previously evaluated both indoor and outdoor shading systems in the Advanced Windows Testbed when there were no simulation tools available to model such systems. Additional field tests are needed to validate these new models. Demonstrations are needed to evaluate actual energy-efficiency performance, human factors, and comfort related to these technologies.

### 3.4.3 Commercialization Potential

Angular-selective exterior and between-pane shading systems have been on the market for over a decade. Exterior screens have been used for solar control in residential and commercial buildings around the world for centuries. Use of between-pane systems, such as Schott North America's OKATECH system, has traditionally been in large-area applications like overhead glazing in atria, airports, lobbies, and such, where indoor shades are impractical and when viewed from afar, the eye fills in and effectively sees an unobstructed view of the outdoors at certain viewing angles.

The Panelite system became popular originally for aesthetic reasons: the architectural community used the system as an expression of design intent, specifying different colored tubes in lobbies or other areas for focal or visual interest. Use of the system for solar control and daylighting is now becoming more common. Over the course of this project, Panelite requested support from LBNL time and time again to characterize product performance for competitive bids on building projects around the world. They found the newly developed modeling tools enormously useful for proving the benefit of their technology over other competitive products. Panelite, a California-based company, was interested in collaborating with LBNL to develop improved products but did not have the in-house R&D resources to develop new materials and manufacturing processes. In the near term, Panelite was very interested in having all their materials and products characterized and entered into the LBNL complex fenestration database. A new organization is being formed in 2014 by industry and U.S. DOE to support such work for all shading attachments on the market.

Photosolar developed the MicroShade product over the course of this project and received considerable attention in the European Union for their innovation. While similar to a conventional perforated screen in appearance, the MicroShade product is ingeniously designed with angular selective perforations at a microscale, enabling use in a dual-pane unit. Such solutions may be the most cost-effective and scalable approach for this class of technology, since it addresses at least three of the four critical performance criteria and requires minimal maintenance, compared to exterior shading systems.

The recent market interest in both the Panelite and Photosolar technologies indicates that there is a growing demand for cost-competitive technologies. As the energy-efficiency codes and standards become more stringent, it is expected that the demand for exterior and between-pane shading systems will grow significantly. The ASHRAE 189.1 standard requires permanent shading devices for south, east and west façade orientations in climates with significant cooling loads. Title 24 2013 encourages use of exterior shading (although the calculation method that it refers to, the National Fenestration Rating Council's NFRC 200, does not accommodate exterior shading) and in some of its climate zones, increased restrictions on window area and window properties are forcing architects to consider shading in lieu of conventional low-e glass.

#### 3.4.4 Benefits to California

Coplanar, static exterior, and between-pane shading systems can provide significant, reliable energy-efficiency and peak electric demand reduction benefits in commercial buildings in California, particularly in sunny, hot climates in the southern and central regions of the state. Angular selective systems provide passive solar control and daylighting, particularly during critical peak periods when it is sunny and hot outdoors. Such solutions can keep the building "livable" in the event of power outages, and maintain the comfort of building occupants both thermally and visually over the course of the year. These systems also enable downsizing of HVAC capacity and use of low-energy cooling strategies such as natural ventilation and radiant cooling by keeping a tight rein on cooling loads in the perimeter zone. Annual energy use intensities in the perimeter zone are approaching levels needed to achieve zero net energy goals.

Estimated market potential is expected to be moderate primarily due to aesthetic reasons. The technology is expected to be of significant value when the energy-efficiency codes become more stringent and as California strives to reach its zero net energy goals.

# CHAPTER 4:

## Dynamic Façades

### 4.1 Introduction

The 2006 California Commercial End-Use Survey estimates that 19,104 GWh per year is due to heating, cooling, and ventilation in commercial buildings and 19,265 GWh per year is due to indoor lighting, totaling 30,369 GWh or 45 percent of the total electric usage in commercial buildings (Itron 2006). Windows provide a unique opportunity to achieve net positive energy use in perimeter zones compared to an opaque wall (e.g., total energy use with daylighting controls is less than an opaque, insulated wall) through the judicious balance of HVAC energy consumption and lighting energy savings. While the static technologies investigated in Chapters 2 and 3 provide practical low-cost technological options to manage both HVAC and lighting energy use, automated fenestration systems offer the potential for greater, more optimized total energy savings in response to variable conditions. The dynamic range of outdoor illuminance and irradiance is orders of magnitude greater than the desired indoor range—static façade systems simply cannot always provide the optimal envelope response to the immediate environmental conditions. With this in mind, the future design of high-performance buildings is expected to involve more active façade technologies, acting in intelligent collaboration with the HVAC and lighting systems to produce comfortable indoor environments with reduced energy consumption.

Benefits include:

- Significant reductions in lighting and HVAC demand, resulting in energy and peak electricity savings and also, in some cases, allowing for downsizing of HVAC systems and the use of low-energy cooling systems that can produce even greater energy and cost savings.
- Increased visual comfort, access to outdoor views, and improved indoor environmental quality through daylighting and glare control.
- Increased flexibility to respond to curtailment events or achieve energy cost minimization goals in concert with the utility grid, microgrids, thermal energy storage systems, and the like.
- Increased flexibility as interior space is reconfigured or space use changes over the life of the building.

Dynamic façade systems involve two key elements: (1) the window component being activated, and (2) the control mechanism or control system algorithm indicating when and how the component is activated. Both dictate system performance. For example, outdoor or exterior venetian blinds are commonly used in Europe to reduce solar heat gains when lowered during the summer (air-conditioning is often not available in the northern climates) and enable passive solar heating and daylighting when raised during the winter. In the 1990s, sophisticated double-envelope façade systems became popular in Europe, where motorized shading was



used as solar collectors in a ventilated deep air cavity, enabling heat rejection and recovery schemes to be implemented at the perimeter zone (Saelens 2002; Lee et al. 2002). Both of these solutions were driven by the desire to reduce or even eliminate the need for perimeter-zone HVAC systems. More recently, in the mid-2000s, automated motorized interior roller shades were used in combination with digital dimmable lighting controls in a 1.6 million ft<sup>2</sup> high-rise office building, where the shades were activated to control direct sun, glare, and daylight; thereby reducing window loads and lighting energy use (Lee et al. 2005). Subsequent to this volume purchase, possibly the largest made in the United States, market and product offerings for automated shading grew significantly, and component costs dropped. These earlier activities set the stage for realizing the goal of zero net energy buildings using whole-building integrated control systems, of which dynamic façades are a critical component.

There remain numerous technical and market barriers to widespread adoption of integrated dynamic façades. This project addresses two critical challenges facing the industry today: (1) the need for practical, low-cost, *integrated* control systems and dynamic façade components, and (2) the lack of independent, third-party data to prove that such systems can deliver the purported performance benefits in the real world.

#### 4.1.1 Smart, Building-Integrated Control Systems

With respect to the first challenge, the biggest caveat in previous research on dynamic façades is whether the facades are controlled well. The problem is that the control systems or “brains” of the operation are not yet very smart. From about the mid-1970s to the early 2000s, the vast majority of commercially available, automatic controls for motorized shading systems offered consumers the ability to simply exclude direct sun from indoor spaces. After about 2005, the majority of manufacturers claimed new automatic control capabilities that managed daylight, glare, and access to outdoor view. The controllers are based on heuristic if-then logic and are independent of the real-time dynamics of other related systems within the building, campus, and utility grid.

Uptake in the market has been slow; there was less than 1 percent market penetration in the early 2000s, and this number has moved only slightly upwards in the past decade. The slow adoption rate can be partially attributed to the economic feasibility of the technology measure. While the industry understands the inherent benefits of such systems, automation is often value-engineered out of the final building. The entire value proposition of such systems can be made more economically feasible by encompassing not only component-level demands but also building or even grid-level demands for performance optimization.

As such, a major focus of the R&D described in this chapter is on devising better controllers for these systems. This has included a variety of controls development techniques, but in the course of the work the focus has settled on the use of model predictive controls (MPC), which provide a comprehensive way of achieving integration between dynamic and complex envelope, lighting, and HVAC systems.

A dynamic façade has some finite number of control variables (e.g., blind slat angle, electrochromic tint level). In the examples considered in this project, this number ranges from

one to three, but it could theoretically be significantly higher. The control logic must specify the values of each of the control variables at any given point in time, in response to some set of input (measured or predicted) values. The performance of a logic controller can be evaluated in terms of a variety of metrics, some of which may be complementary and others contradictory: occupant-reported satisfaction, “measured” glare probability (running high dynamic range (HDR) camera images through a DGP algorithm), workplane daylight level, electrical lighting energy consumption, zone thermal load, or HVAC power consumption. Many different ways of specifying the control logic may be possible, such as through feedback laws (e.g., on-off control, proportional-integral-derivative controller [PID]), input-output rule-based logic (e.g., IF-THEN trees [by far the most common current approach to façade control] or fuzzy logic, in both cases written a priori by people, hopefully experts), occupant manual control, learning algorithms based on occupant manual control, model-and-optimization-based control, or some combination of any of these.

Proportional-integral-derivative control (or on-off control) is nearly always worth considering first, if the nature of the control variables and control objective allow it to be used directly. For example, standard household heating temperature control (local-loop) is simple because the objective (zone temperature relative to its setpoint) is directly measured, there is just one control variable (single-input-single-output), and the actuation’s effect on the objective is monotonic. This would also be the case for a dynamic façade with a single control variable, with an objective to maintain desktop illuminance at a particular level (assuming that the control variable’s effect on desktop illuminance is monotonic, as would be the case with, for example, electrochromic tint level). It becomes slightly more complicated if a control objective or constraint is not directly measurable (or not directly measurable in a cost-effective way), such as with glare or perhaps with zone thermal load, but these could be estimated from other measured values by using a model.

However, dynamic façade control problems are rarely this simply fit to PID control. The objective is rarely directly measurable, and is often a combination of objectives and constraints (e.g., to maximize illuminance while staying below a glare threshold). Control variables are often discrete instead of continuous, which can make the problem more difficult. The controller is often only allowed to be intermittent rather than in continuous time. Electrochromics take a long time to change state. Automated venetian blinds often have motors for controlling them that cannot be constantly turned, and will only turn a minimum of 5°. And everything becomes more difficult when there are multiple control variables with interacting effects on the objectives (e.g., two-zone venetian blind control).

Perhaps for these reasons, or perhaps for other practical reasons, the state of the art in automated dynamic façade control is generally something like a “block beam” controller for venetian blinds or roller shades, which is configured to simply block any direct beam (in the case of roller shades, keeping the direct beam to a certain depth from the window) but otherwise stay as open as possible. A “block-beam” control law is convenient in that it is only dependent on the time of day and day of year, the fixed external geometry, and the geometry of the shading device, so it can be calculated without any sensors. It also does a fairly good job on the various performance metrics, usually keeping glare probability low enough simply by

blocking the orb of the sun, generally allowing for adequate diffuse daylight in the space, and reducing the zone cooling load by taking out most of the solar thermal load. However, it does not always keep glare levels low enough, particularly on overcast days. In low outdoor light level conditions, it may not always let in as much light as it should. And it may not always minimize the thermal load. To deal with some of these issues, the block-beam rule may be modified by another rule,<sup>9</sup> or overridden by occupants. If occupant overrides are allowed, then a learning system can be set up to automatically mimic their overrides.

In attempting to improve upon existing dynamic façade controllers, one could try to build upon the best available rule-based controllers, augmenting them with more complex expert rules (perhaps using fuzzy logic, for example) and/or with more feedback control overrides and/or with more occupant overrides and/or learning algorithms. Such attempts may be valuable and practical in some cases. Our research has taken a somewhat different approach, one that can improve upon existing controllers for existing dynamic façade systems, but which also has an eye to future dynamic façade implementations with many more interacting control variables. Model predictive control allows us to explicitly consider control objectives and constraints in the construction of the controller. If done well, it can result in more nearly optimal control responses relative to these objectives. And it also allows us to deal with any number of control variables or any level of objective complexity, all within the same general framework. If necessary, the same process of making piecemeal improvements can be done with MPC controllers as would be done with existing rule-based controllers—augmenting them with additional expert rules and/or feedback control overrides and/or occupant overrides and/or learning algorithms.

Model predictive controls can yield significant reductions in energy use and peak demand, enable greater responsiveness and stability of the utility grid as alternative renewable energy sources come on line, and improve occupant comfort and the indoor environmental quality of buildings. It is a common controls technique in other fields, particularly in the chemical, automotive and aerospace industries, and has been shown to be potentially beneficial for many aspects of building controls, although perhaps with some modifications to make the techniques more appropriate to the particular context of the buildings industry.

The central idea of model predictive control is that a model of the system is repetitively interrogated to determine the best control strategy given some particular set of weather conditions and other sensor readings or other building or occupant-related information, potentially including weather forecasts. Formally, MPC consists of a repeated real-time solution of a finite-time-horizon optimization problem with a model of the system under consideration. (If no prediction is used, the problem is treated the same, but the horizon is just one timestep long.) Only the first timestep of the solution is applied to the actuation of the real system, and

---

<sup>9</sup> In the block-beam control algorithm used for comparison in the studies herein, the venetian blind angle was overridden to be horizontal whenever the measured outdoor illuminance was below a particular threshold. In rare cases, such as the New York Times Headquarters, a block-beam control law may be coupled with a feedback-law override to keep the measured window plane illuminance below a specified threshold.

the optimization problem is then repeated for the next timestep (with updated initial conditions and predictions).

Although most often applied to the control of dynamic systems involving significant capacitance of thermal lag, MPC is also potentially useful for the control of dynamic façade systems. This is because it allows for the consideration of any level of complexity in the façade system and its interactions with other systems (primarily lighting and HVAC, but also distributed generation elements and/or the electricity grid). It also offers a rigorous method to deal explicitly with visual discomfort glare probability, which has proven difficult to consider heuristically or through proxy measurements.

Model predictive controls have received significant research attention in the buildings industry (primarily for HVAC control) in the past five to ten years, but have not yet broken into the mass market. In its conventional configuration, MPC requires that the controller run the model within an optimization loop in real time. This “online” mode of control has been considered in some of the R&D work described below. However, online optimization is potentially a very computationally expensive prospect for a (low cost and thus computationally-limited) embedded controller in a dynamic façade system (and for building systems in general). The MPC approach has been successful in the chemical processing industry because each plant is valuable enough to warrant significant investment in customized controls. It has been successful in some aerospace and automotive applications because of a combination of unit value and production environments that allow for a concentration of controls expertise to influence a large number of units. Buildings, on the other hand, tend to be designed as one-off projects, and the energy cost savings available through each individual MPC implementation tend to be relatively modest. This, combined with a high one-time cost associated with controller development and installation, usually results in a relatively poor payback period. Additionally, the complexity of the arrangement generally scares off most designers, installers, and building owners.

With these market barriers in mind, the R&D work described below has focused on developing and evaluating low-cost methods of producing controllers that approximate MPC. These “off-line” controllers are created by first developing a conventional MPC configuration in a virtual environment, sampling its behavior over a broad range of environmental conditions to produce a lookup table of optimal control responses, and then using this lookup table with interpolation to control the system. These methods for approximating MPC are described in detail in (Coffey 2011b). The R&D work described below also goes one step further in addressing market challenges by demonstrating a system that fully automates and encapsulates the modeling, optimization and controller construction processes, allowing a non-expert to produce customized near-optimal controllers for their particular system.

#### 4.1.2 Low-Cost, Dynamic Façade Components

The need for low-cost controllable façade components is another challenge facing industry. Motorized shading systems have typically been viewed negatively in the United States, not only because of the added capital cost but also because of the potential long-term maintenance cost. Chromogenic windows hold several distinct advantages over motorized shading systems:

(1) the windows tint but remain transparent to preserve views out (similar to photochromic sunglasses), (2) the switchable coating or glazing layer rejects solar heat gains on the outboard layer of an insulating glass unit, achieving more efficient solar control than most between-pane or interior shading systems, and (3) switchable glass requires less maintenance than a mechanized system and cannot be damaged by the occupants or outdoor elements (e.g., ice, snow, wind, birds).

Large-area, durable, chromogenic window products are just emerging onto the buildings market. Electrochromic coatings (EC) are switchable thin-film coatings applied to glass that can be *actively* controlled to change appearance reversibly from a clear to a dark blue tint when a small direct current (dc) voltage is applied using a manually operated switch or an automated building control system. Thermochromic windows are a class of chromogenic devices that switch *passively* when the surface temperature of the glass changes. Because they are passive devices requiring no wires, power, or controls, the capital and operating cost of this technology can be significantly less than electrochromic windows.

Switchable glazings have been used for eyewear, rearview mirrors, and in luxury vehicles and boats for about a decade. More durable, small-area electrochromic skylights and windows were offered commercially for niche applications on residential and commercial buildings in the early 2000s as the industry transitioned from laboratory devices to pilot production facilities. By 2013, electrochromic and thermochromic windows started to be produced in the United States by multiple vendors using high-volume manufacturing plants, enabling lower cost, larger area windows to be specified. Both technologies are in the late R&D stage of development, where cost reductions and performance improvements are under way. Electrochromic windows have been installed in numerous buildings, but building performance has not yet been independently evaluated. Thermochromic windows have been installed in a more limited number of buildings but independent evaluations have also not been conducted.

In this project, we characterized the switching properties of emerging thermochromic windows to determine if they were suitable for commercial building applications. Because both near-term thermochromic and electrochromic window technologies switch across the entire spectral range, we also investigated the technical energy-savings potential of near-infrared (NIR) switching thermochromic and electrochromic windows, in order to provide guidance for future material science developments.

#### 4.1.3 Implementation and User Acceptance in the Field

The final critical challenge that this project addresses is the lack of third-party data and information needed by purchasers to understand what is involved with implementing such systems in their buildings. Potential purchasers need to know whether there are hidden costs associated with installation and long-term maintenance of the systems, if the systems will deliver the claimed performance benefits over the life of the building, and most important, if the technology will be acceptable to end users.

Over the term of this project, there have been several opportunities to collaborate on demonstration projects. PIER program funding provided seed funding to develop the

fundamental capabilities needed to conduct the analysis on the projects. The DOE Emerging Technologies, DOE Commercial Buildings Integration Program, Federal Energy Management Program, and the U.S. General Services Administration (GSA) Green Proving Ground Program provided the funding needed to be actively involved in the monitoring and evaluation of the projects. The California Emerging Technologies Coordinating Council (representing the California utilities) was approached, but the scope of façade demonstrations exceeded the scope defined for their programs.

Demonstration projects enable an in-depth analysis of the processes needed to design, implement, install, commission, and maintain dynamic façade systems and allow others to learn from leading-edge adopters. While the measurements in the LBNL Advanced Windows Testbed are accurate and detailed, demonstrations offer the opportunity to evaluate real-world building performance under occupied conditions. This combination of data from various sources—bench-scale laboratory measurements, building energy simulations, outdoor testbeds, and real buildings—enables stakeholders to better understand the overall performance impacts of innovative technologies.

In Section 4.4, summary results and lessons learned are given for several commercial office building projects that demonstrate use of switchable electrochromic and thermochromic windows, motorized roller shades, and motorized exterior venetian blinds.

In all three areas of research, industry was intimately involved in the development and use of the control system modeling capabilities, material science developments, and demonstration projects. The research was targeted to be at the forefront of technological innovation to achieve very low energy goals, and we shared tools and lessons learned with industrial partners such as Philips North America, MechoSystems, View Dynamic Glass, Sage Electrochromics, Pleotint, Ravenbrick, Warema, and Hunter Douglas/ Nysan/ Embeddia. Activities with these partners are discussed in the sections below.

## **4.2 Building-Integrated Control Systems**

This section describes the development of tools and techniques for advanced controls for dynamic façade systems. A hardware-in-the-loop testing environment was developed. Online model predictive control (MPC) implementations were developed and tested for daylight maximization (subject to glare constraints) and energy minimization. The concept of “offline” MPC (virtual sampling of a MPC configuration over a range of conditions to produce a lookup table for real-time control) was investigated for integrated control of shading and under floor air distribution (UFAD) systems, and for shading and radiant cooling. Finally, a web-based application was produced, automating the process of creating an “offline” MPC controller in such a way that a non-expert user can customize the controller configuration, click a button, and receive automatically generated controller code ready to be embedded on a simple control chip and used in the field.

#### 4.2.1 Hardware-in-the-Loop Testing Environment at the Advanced Windows Testbed

##### *Approach and Goals*

The LBNL Advanced Windows Testbed (Building 71T) consists of three highly instrumented test chambers which may be used to evaluate a wide variety of façade and lighting technologies in terms of their energy (including HVAC load), daylighting, and visual comfort performance. For various dynamic façade tests, different shading systems (or electrochromic windows or thermochromic windows) may be mounted in the test rooms and evaluated.

In order for the testbed to be used for dynamic façade controls testing, a system was constructed to allow researchers to read any of the many sensor points and control the shading and lighting systems, all through a hypertext transfer protocol (http) interface. This allows researchers to develop control algorithms on any platform, interacting with the sensors and actuators by writing simple send and get scripts that are issued through the http interface. The system was constructed using a combination of LabView and the Building Controls Virtual Test Bed (BCVTB (Wetter and Haves 2008)). The details of its configuration are described in (Wen 2011).

##### *Outcomes*

The resulting controls testing environment was used not only for the controls development projects described below, but also for collaborative work with Phillips North America, where a model-based control was designed to regulate daylight and avoid discomfort glare by adjusting the slat angle of an interior venetian blind using sensor inputs from both the outdoor weather station and from the room interior. Philips reported both lighting and HVAC energy savings in a conference publication (Wen et al. 2011). View Dynamic Glass attempted to use the BCVTB model to develop control strategies, but core EnergyPlus and Modelica software modules for modeling switchable windows had not yet been developed. These were developed later in the project. MechoSystems developed and tested a dual-zone shading control system over a solstice-to-solstice period by sending commands from their controller remotely to the BCVTB interface. Data from the manufacturer's and LBNL sensors were exchanged on a 1-minute timestep for control and evaluation. The experience of constructing and using the system has also provided a useful precedent to LBNL's new FLEXLAB facility.

#### 4.2.2 Online MPC: Daylight Maximization Subject to Glare Constraints

##### *Approach and Goals*

The purpose of this project was to provide a first proof-of-concept attempt at MPC controls at the Advanced Windows Testbed, to better understand how MPC works, identify its necessary inputs and assumptions, and determine how it might play out across the building life cycle. This proof-of-concept attempt was also used to determine if it was worth continuing to investigate MPC as an option over the full term of the project.

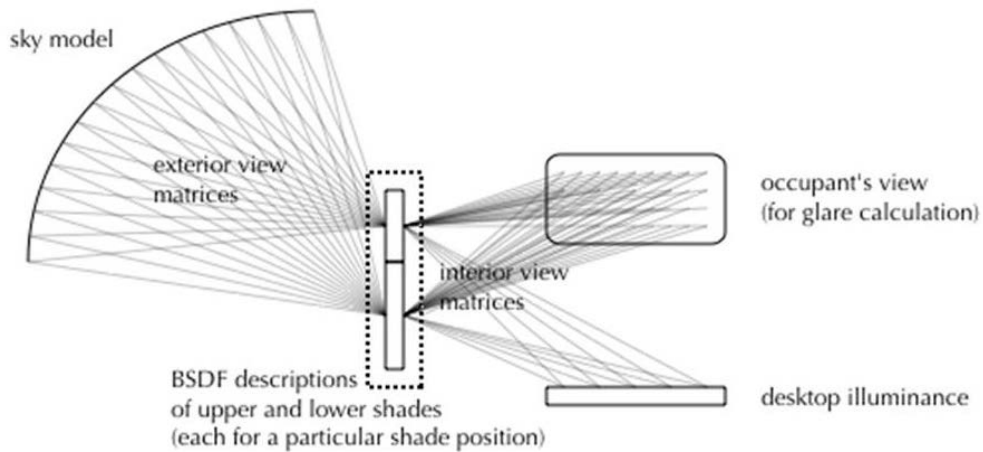
##### *Outcomes*

Model predictive control controllers were constructed for two test cases, a two-zone exterior venetian blind and a retractable awning, both for use within the Advanced Windows Testbed.

In both cases, the control objective was to maximize daylight illuminance on the workplane without exceeding a glare threshold (daylight glare probability (DGP) < 0.42). The model used in the MPC was constructed in Radiance and uses the three-phase method (i.e., `dctimestep` subroutine) described in Chapter 2 (Figure 40). Exterior view (“daylight”) and interior view (“view”) matrices were constructed based on a detailed Radiance description of the geometries and surface reflectances at the Advanced Windows Testbed. Extending the technique from static CFS to dynamic CFS was simply a matter of replacing the single BSDF with a set of BSDFs, one for each possible (or desired) state of the dynamic façade system, with the current state selected from the set for use within the `dctimestep` call. The outputs from the `dctimestep` command were postprocessed to calculate the average workplane illuminance and the DGP (using the `evalglare` software tool). The overall model can thus be described as follows:

[DGP, average workplane illuminance] = model (day of year, time of day, direct, diffuse, shade position)

**Figure 40: Illustration of `dctimestep` matrices configuration for a particular case**



Source: Coffey et al. 2013a.

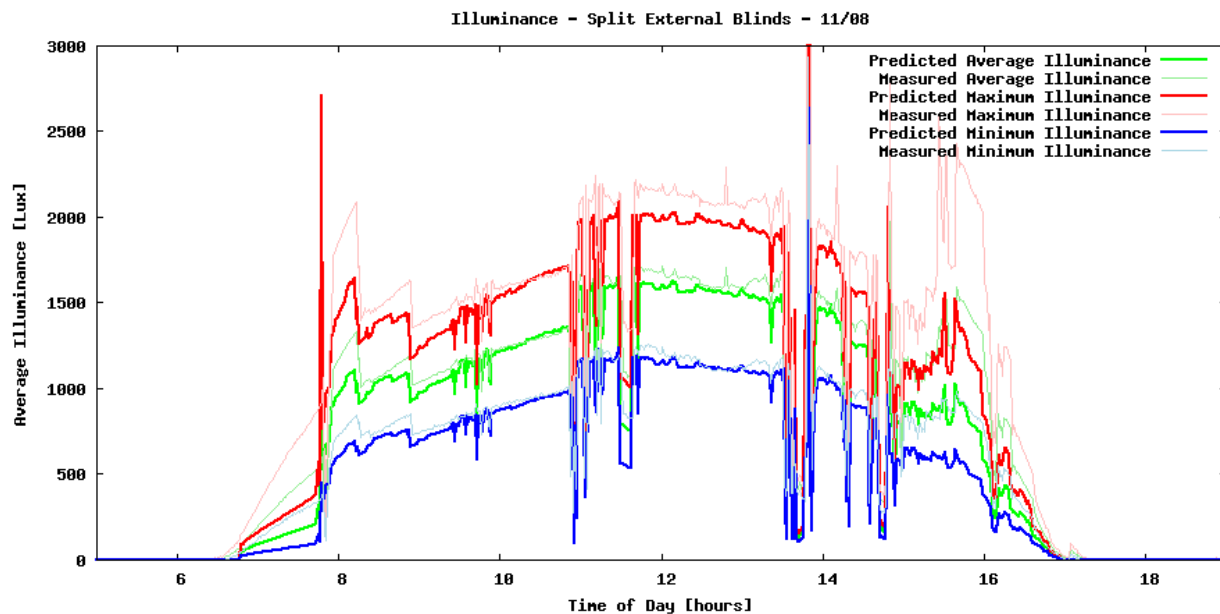
At each controller timestep, the solar conditions were read from the sensors at the Advanced Windows Testbed, and the model was run for every possible shade position (in the case of the two-zone blind, this means every possible combination of upper and lower slat angle or retracted position). The shade position that resulted in the highest modeled workplane illuminance without exceeding the modeled DGP threshold of 0.42 was identified and sent to the testbed as the controller setpoints to actuate the blinds accordingly.

The proof-of-concept attempts with both the two-zone exterior venetian blind and retractable awning were successful. The systems worked: the software pieces all fit together properly, the BCVTB/ http I/O system described above worked properly, the research team could view operations in real time, and the team could perform minor tuning adjustments to the controller (by changes to the MPC model) to improve agreement between modeled and measured illuminance and glare. Figure 41 shows some workplane illuminance results (red is for the



sensors closest to the window, blue for those furthest, and green in between) for a day of MPC operation with the 2-zone exterior venetian blind. In all, the proof-of-concept attempts demonstrated both the power of MPC for dynamic façade control and its feasibility (at least within a research setting). It also convinced the research team to continue to pursue it through the length of the overall project.

**Figure 41: Illuminance-maximizing control implementation**



Source: LBNL.

Some objectives for further research were also highlighted by this project. More advanced optimization algorithms (rather than the exhaustive parametric search) could be used to speed up the controller and allow for it to be used on more challenging problems (such as those described further below). And at least two practical implementation concerns must be addressed for MPC to find market uptake: First, this project required a lot of modeling effort to produce the MPC, which could not be replicated for every new MPC implementation. Second, it used a laptop to control the shading system, which is not scalable. These considerations were addressed later, as described in the sections below.

#### 4.2.3 Online MPC: HVAC Energy Minimization (Perimeter Zone System Loads Minimization)

##### *Approach and Goals*

This project was intended to provide a second proof-of-concept exploration of MPC for dynamic façades, again by building a controller and testing it in full scale at the Advanced Windows Testbed. In this case, though, the objective of the controller was to minimize HVAC load with the objective of exploring whether there were any benefits associated with integrating with the HVAC system, determining if it would improve HVAC operations, and identifying the issues and challenges with HVAC integration.

## Outcomes

After attempts to evaluate MPC with EnergyPlus, we found it unmanageable, primarily because the software does not allow for state reinitialization (i.e., the room heat balance is reinitialized at each timestep to the thermal conditions associated with the selected position of the controllable shading, lighting, and HVAC elements). Therefore, Modelica was used for modeling, which allows for simple state initialization. To model windows, the open source *Buildings* library (Wetter et al. 2014) was extended in two major ways:

1. A Modelica implementation of the modeling algorithms used in WINDOW 7 to calculate the window heat gains through specular glass had to be written. This new addition to the *Buildings* library is described in (Nouidui 2012).
2. The new technique that allows for the use of Radiance-calculated interior solar gains and window-absorbed gains values in EnergyPlus (discussed in Chapter 3) was replicated in the *Buildings* library. Although it was a complicated process to modify the EnergyPlus code, it was a simple adjustment to the *Buildings* library because of its open and modular nature. However, the process of deriving the absorbed solar gains requires the use of a combination of Radiance and WINDOW 7, which will require further simplification before it can be readily used by other modelers.

With these modeling tools in hand, a combined Radiance-WINDOW-Modelica model of the Advanced Windows Testbed was constructed. The previously noted Radiance model of the testbed was used to construct the new interior view matrices required for the solar gains on the surfaces. WINDOW 7 was used to produce window layer absorption matrices. Finally, a Modelica model of the room (using the Radiance-derived solar gains as exogenous inputs) was constructed using Dymola and the newly extended *Buildings* library.

A single-zone external venetian blind was used as the controllable element, restricted to ten different blind positions (fully retracted and fully deployed with nine slat angles between horizontal and fully closed downwards). The control objective was to minimize the test room's net heat flow by varying the blind position, where the HVAC system was defined as a simple PID controller designed to keep the room temperature within a defined deadband temperature range.

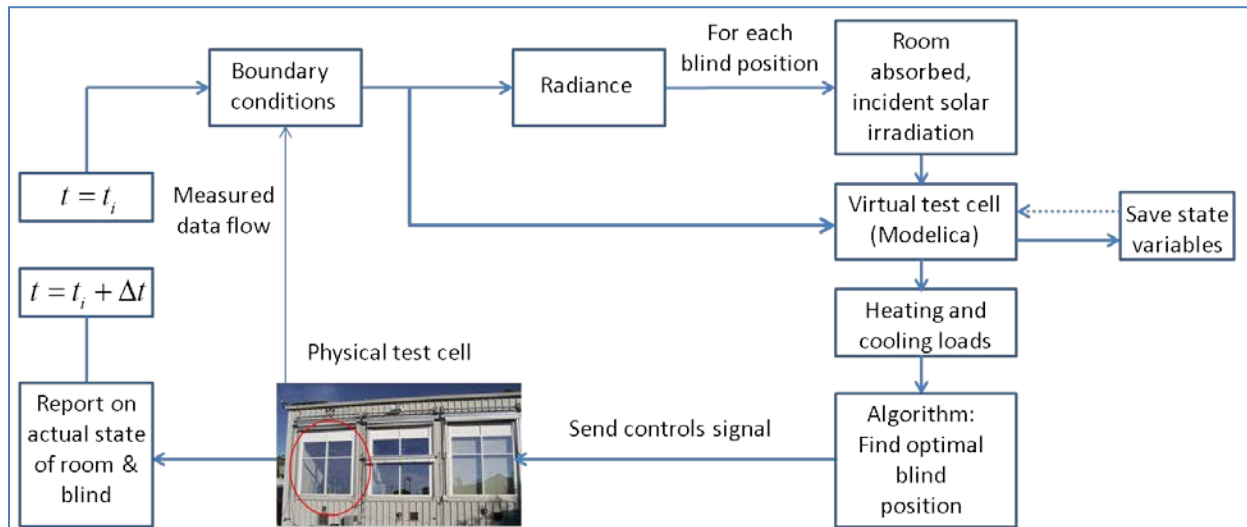
In the course of this project, a fairly generic framework (Figure 42) was produced that allowed on-line optimizations to occur at the supervisory level given complete simulation models and inputs for prediction. This implementation was significantly more complicated than the daylight/glare optimization described in the prior section: it required more model inputs and state re-initialization. The framework included several unique components, in addition to the Radiance-WINDOW-Modelica modeling, including the following:

- a. Supporting Python and Perl scripts that implement any arbitrarily defined control algorithm, managing inputs, conducting the necessary calculations for each combination of states of the controlled devices (dynamic façade, lighting, and HVAC), selecting the

optimum state, computing performance outcomes, then reinitializing state variables in preparation for repeating the calculations for the next timestep.

- b. A link of the framework to the Advanced Windows Testbed via the Building Controls Virtual Test Bed (BCVTB), enabling real-time actuation of hardware components in response to weather conditions, internal loads, etc. (see Section 4.2.1).

**Figure 42: Simulation-based controls framework developed in this study**



Source: Nouidui et al. 2012.

The framework was debugged and evaluated over a six-month period and determined to work as intended. This work is documented in (Nouidui 2012). It demonstrated a sandbox/ build-test-reiterate capability for manufacturers using Modelica, and identified a viable workflow/ path for further development of HVAC control systems using the online MPC approach.

#### 4.2.4 Offline MPC: Lighting and Under Floor Air Distribution (UFAD) Energy Use Minimization

##### *Approach and Goals*

Two of the practical challenges that need to be overcome in order for MPC to be accepted by the market are highlighted in the studies described above:

1. Both studies required a considerable amount of effort for custom modeling. How feasible is it to use building energy models originally intended for a different purpose (e.g., design phase models) for MPC? Would this adequately cut down the required modeling time?
2. For real-time control of a shading device, both studies used a laptop with a complex collection of scripts and modeling software (in the first study, just Radiance, but in the second study both Radiance and Dymola were being used in calculating the shading device position setpoint). Is it possible to simplify this such that the controller can be

easily embedded on a simple chip or easily integrated into an existing building control system?

One possible response to these challenges is to use the existing models to construct virtual MPC configurations on a cloud computing platform, use them to calculate optimal control setpoints over a wide range of conditions, and then use the resulting database of optimal control results as an interpolation lookup table during real-time operation. The simulations thus all happen a priori rather than in real-time. With this approach, model complexity is somewhat less of a concern (e.g., complicated models in Dymola and Radiance can be run on the cloud, without time constraints, rather than in real time on a controller). Also, the implemented controller is a simple lookup table with interpolation which can be easily embedded on a small chip or used within an existing control system. This approach, denoted as “offline MPC” herein, is described in detail in (Coffey 2011b) with a variety of case studies.

The goal of this project was to provide a proof of concept of offline MPC for a complex optimization problem involving a dynamic façade, in a real-building case, with an EnergyPlus model already available. In the process, we addressed the following questions:

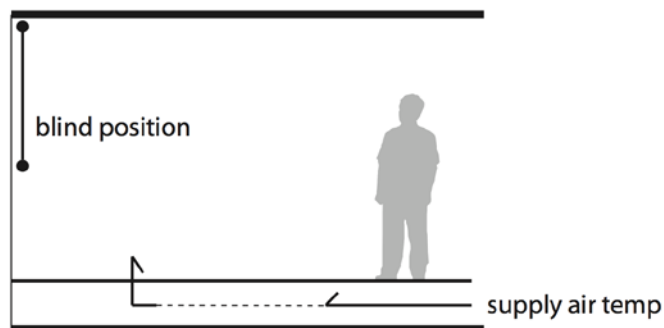
- Is the problem solveable?
- What workflow is required?
- How does one constrain the conditions grid in order to find the optimum control actions in a time/cost-effective manner, without sacrificing too much performance?

With this project, we also explored the question of whether or not we can use MPC to achieve more savings than heuristic controls by considering interactions between dynamic façades and HVAC systems.

### *Outcomes*

The study was based on a control optimization opportunity that had been identified in another project with an office building in New York. This building has a UFAD system and motorized blinds, both of which are well controlled, but controlled independently. The control optimization challenge/opportunity was to produce a controller that could provide integrated control of the blind position and the UFAD supply air temperature (Figure 43), in order to minimize the combined lighting and UFAD energy use.

**Figure 43: Illustration of the control variables considered in this study**



Source: Coffey 2011a.

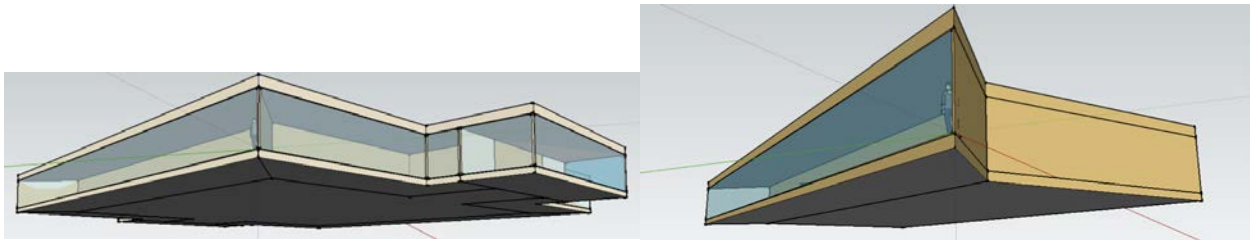
This would be a very difficult control problem to optimize with a heuristic approach; a model-based approach is appropriate. To determine the optimal control setpoints for this system, optimization must consider various complexities, including:

- the trade-off between thermal loads and lighting energy consumption for different blind positions;
- the effects of solar gains to the floor on thermal decay in the UFAD system, which effects supply air flow rates and feasible supply air temperature ranges, and thus cooling coefficient of performance (COP) and the potential for economizer operation; and
- capturing the solar gains at the blind, which creates a plume that drives thermal stratification in the zone, which affects cooling COP.

Because of the inherent complexities of the problem, it is difficult to determine control rules that would minimize the energy use under all possible conditions. However, these complexities had already been accounted for in an existing EnergyPlus model of the building.

An EnergyPlus version 6.0 model of a single floor of the building had already been constructed for other purposes (Webster et al. 2013). A one-perimeter-zone extraction from that model (Figure 44) was used to produce the controller in this project.

**Figure 44: EnergyPlus model and the one-perimeter-zone extraction**



Source: Coffey 2011a.

The extracted one-perimeter-zone EnergyPlus model was used within a virtual MPC configuration on the Amazon Elastic Compute Cloud (EC2), using GenOpt as the optimizer, as described in (Coffey 2011a). Some additional minor modifications to the model were necessary for this purpose (documented in (Coffey 2011a)), including changes because of the assumption of negligible thermal mass when solving the optimization problem (this assumption vastly simplifies the MPC problem, as discussed in the next subsection). Also, the EnergyPlus model requires a lot of weather inputs, many of which are either well-correlated to another weather input or do not have a significant impact on the model outputs—a pre-processing step is used in the MPC configuration to calculate all of the input variables as functions of a small set of inputs that can be easily measured. The virtual MPC configuration was then tested over a range of 2,475 different weather conditions (the product of 11 ambient temperatures, 5 direct normal radiation values, 5 diffuse horizontal radiation values, 3 days of year, and 3 times of day), and the resulting lookup table of optimal control responses was used to produce a simple interpolation lookup table controller.

The lookup table controller was then tested through annual simulations and compared to baseline control cases. (Note that the assumption of negligible thermal mass did not apply to the model used in the annual simulations, only to the way the control logic was derived.) The controller was found to reduce HVAC energy by 5 percent over a simple baseline controller.

This project provided a successful test case/proof-of-concept, illustrating how off-line MPC can work for integrated control of dynamic façades and HVAC systems. It also explored some of the practicalities of the approach. The selection of control variables (e.g., supply air temperature rather than other parts of the UFAD operation) required some engineering judgment. Limiting the number of model inputs through the pre-processing input-correlations step is necessary both for the computational feasibility of the approach and for the practicality of using the resulting lookup table within a real controller, given the practical limits of sensing in real building applications (i.e., since when do we ever have all the inputs that EnergyPlus requires?). Again, engineering judgment was used in this part of the process—further research could help to identify what inputs are critical for proper control and how we might measure that cheaply in the future (e.g., direct/diffuse radiation). Other possibilities for further research were also identified. For example, in this study only linear interpolation was used within the lookup table controller; future research should consider other interpolation techniques. This project also highlighted a particular benefit of this approach to controls development: simple visualization

graphs of the resulting solution space can help the engineer better understand how the underlying system works and how an optimal controller for that system should behave. This visualization also helps in the process of constructing and debugging the controller; for example, by helping the engineer to understand how to select an appropriate resolution for the grid of conditions.

#### 4.2.5 Offline MPC: Total Energy Use Minimization with Dynamic Façades + Radiant Cooling

##### *Approach and Goals*

Low-energy cooling strategies that include thermal mass (such as radiant slabs and/or nighttime ventilation for passive cooling) provide a particular challenge/opportunity for integrated control with dynamic façades. Questions such as how to control the shades and HVAC to minimize loads during peak afternoon periods, or how to optimize trade-offs between solar heat gains and daylighting, can be addressed with MPC.

Constructing MPC controllers for these types of control problems, however, may or may not be feasible with simulation tools like EnergyPlus and/or with offline MPC. These types of problems may require long prediction horizons (e.g., 24 hours), which means that both:

- the optimization problem at each instance is much larger (since the control setpoints for each timestep over the horizon must be solved), which makes the MPC problem itself (either online or offline) much more difficult, and
- the conditions grid is potentially also much larger, since the predicted values over the horizon must be considered.

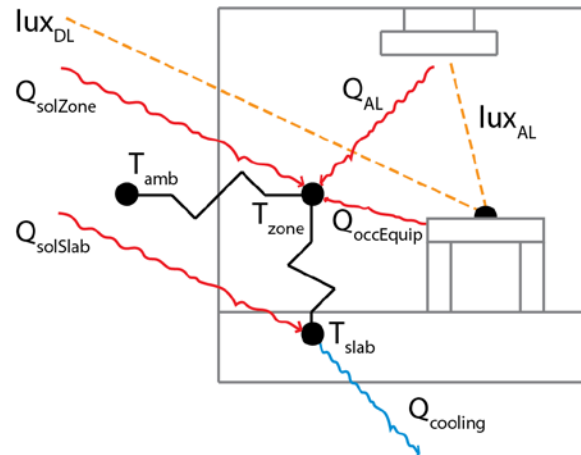
The primary goals of this project were (1) to investigate the feasibility of approaching this problem with simulation tools like Modelica, EnergyPlus, and GenOpt, and with the offline optimization approach to deriving a simplified controllers, and (2) if necessary, to develop modifications or alternatives to particular aspects of the approach. Insofar as possible, this project also sought to estimate energy savings potential with MPC for dynamic façades and radiant cooling systems. Case studies were considered that were all variants on an EnergyPlus ASHRAE 90.1-2010 office building, modified to use radiant slabs and either operable venetian blinds (internal or external) or electrochromic glazing. In each of the case studies, the control optimization was set to minimize the combined cooling and lighting energy over a 24-hour prediction horizon, subject to zone temperature minimum and maximum (min and max) constraints, with the hourly shade position and slab cooling amount as control variables.

##### *Outcomes*

Initial investigations made it clear that using the EnergyPlus model directly as the model within the MPC controller would be far too computationally expensive to be feasible. A proxy model was developed with a reduced-order simplification of the thermal zone and HVAC aspects of the model, but which still allows for any arbitrary level of complexity in the shading system. (The main part of the model is illustrated in Figure 45—the model also contains a simple lighting energy model and a cooling COP curve as a function of outdoor temperature.) An

automated calibration method was developed to get this proxy model to approximately mirror the behavior of any EnergyPlus model with radiant slabs and dynamic façade systems. (Note that the proxy model can also be calibrated to match measured building data, and/or that a Radiance BSDF approach could be used for the solar and daylighting aspects of the model.) This proxy model is then used as the MPC model.

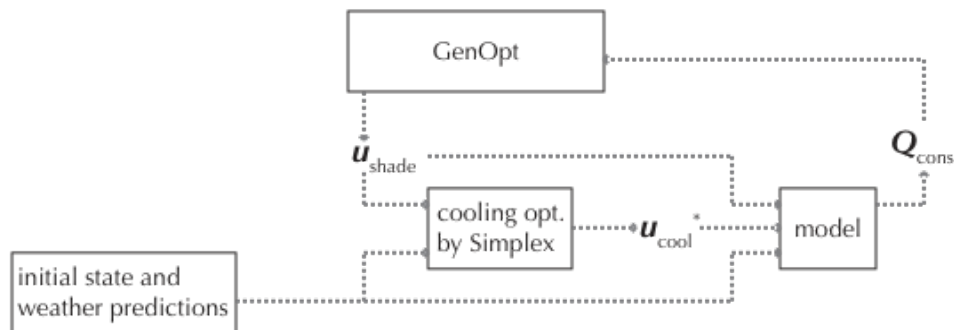
**Figure 45: Illustration of the proxy model structure**



Source: Coffey 2012a.

The structure of the proxy model allows the thermal part of it to be formulated linearly, which in turn allows for the slab cooling part of the optimization to be solved analytically. As such, the energy-minimizing optimization (subject to zone temperature constraints) of control inputs for radiant cooling level and shading position over the 24-hour prediction horizon was split into two levels, with GenOpt used at the top level to deal with the complexity of the façade, alongside a linear programming solution to the chilled slab control, as shown in Figure 46 (note that  $\mathbf{u}$  and  $\mathbf{Q}$  represent vectors of values over the 24-hour prediction horizon). This split structure makes the overall optimization with GenOpt much faster and more precise.

**Figure 46: Illustration of the two-level optimization structure**



Source: Coffey 2012a.

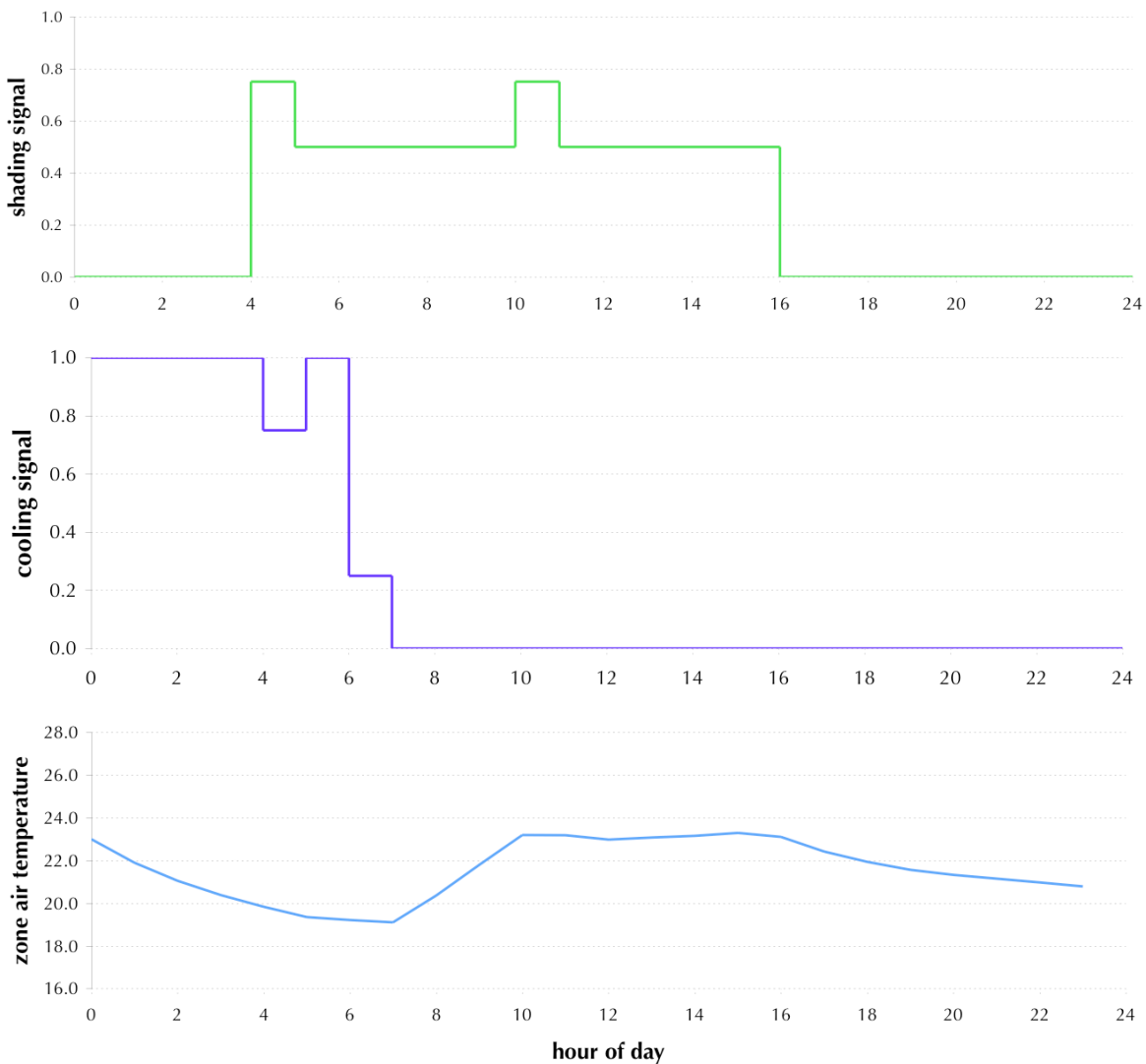


With this fast solution to the MPC optimization in place, the offline-optimization approach was made feasible by limiting the controller inputs to minimum and maximum values of the temperature, direct and diffuse over the 24-hour prediction horizon, and using average daily curves for these values to fill in the rest of the hours (described in detail in (Coffey 2012a)). The MPC was then sampled to determine the optimal control configuration for a grid of conditions that cover the range of conditions (e.g., weather, occupancy) that the system is expected to address when in operation. The resulting lookup table was then used with interpolation for real-time control.

An example of the optimal control trajectories over a 24-hour prediction horizon are shown in Figure 47 for one particular set of conditions, for the case of a south-facing façade in Chicago.

**Figure 47: Example shading and cooling control trajectory over a 24-hour prediction horizon**

{ $T_{ambMax}=30$ ,  $T_{ambMin}=15$ ,  $Q_{directMax}=500$ ,  $dayOfYear=182$ ,  $hourOfDay=1$ ,  $T_{zone0}=23$ ,  $T_{slab0}=21$ }



Source: Coffey 2012a.

As a first-pass attempt to quantify energy savings potential with this control approach for these types of systems, the team simulated a variety of case studies. Three different operable shading technologies were considered, in four different climates, and for two different orientations. The three operable shading technologies were external venetian blinds, internal venetian blinds, and electrochromic windows. The four climates considered were Chicago, Houston, New York, and Sacramento. The two orientations were south and west. Two different control configurations were considered: “lookup,” which used the lookup table for both the shade position and cooling setpoint; and “luOptCool,” which used the lookup table for the shade position and performed a real-time optimization for the cooling setpoint based on the measured sensor readings. This runs very quickly because the optimization problem at that point is entirely linear and can be solved with a simplex algorithm in Java, so it could conceivably be embedded on a small chip or integrated into an existing building control system. The controllers’ performance was compared with that of a variety of simple base-case controllers. Some of the results, with the “lookup” and “luOptCool” control configurations compared with the best of the base-case controllers, are shown in Table 1 below.

**Table 1: Summary results of approximated MPC performance in this study showing percentage savings relative to the best available base case controller tested**

		Chicago	New York	Houston	Sacramento
External Venetian blinds, South	lookup	2.6	3.5	-0.3	4.8
	luOptCool	5.8	6.5	2.4	7.3
External Venetian blinds, West	lookup	-0.2	0.3	-0.3	0.1
	luOptCool	2.3	3.0	1.7	2.5
Internal Venetian blinds, South	lookup	0.2	0.9	0.3	0.5
	luOptCool	3.5	3.6	2.2	2.9
Electrochromic windows, South	lookup	3.3	3.7	-1.0	-9.7
	luOptCool	6.6	6.7	2.0	-4.9

Source: Coffey 2012a.

It should be stressed that most of the effort went into creating workflow; the simulated energy savings outcomes are of interest but only indicative at this point and not fully conclusive. Some of the results point to possible small errors in some of the controllers. Ideally, these annual simulation tests would also be run in EnergyPlus, but since EnergyPlus is limited in its ability to simulate these controllers, a simulation tool needs to be developed.

On the whole, this project developed methods for devising near-optimal controllers for active façade systems coupled with thermally-massive HVAC systems such as radiant floors and ceilings. The methods developed in this project use a proxy model with a reduced-order thermal model that can be automatically calibrated to mirror EnergyPlus outputs, while still allowing for any arbitrary level of complexity in the façade system. If made more robust, slightly better performing and easier to construct (and this project highlighted various ways of doing all these things), the approach outlined in this study could offer a practical way of providing near-optimal control for these types of systems.

## 4.2.6 Offline MPC: Bringing it Together: A Cloud-Based App for Embedded Controllers

### *Approach and Goals*

Modeling and optimization approaches were established through test cases in above sections. This final project aimed to provide a final proof of concept by reduction to practice. It builds on the modeling approaches in the previous cases, and addresses some of the market uptake concerns that were highlighted by them. In particular, it aims to provide a solution that addresses the following concerns:

- Controller development: complexity, customization, cost of labor, and computing
  - The first two MPC projects required modeling effort beyond the resources of a typical project to produce the MPC. This could not be replicated for every new MPC implementation in practice. We have shown in the previous “offline MPC” projects that models constructed for other purposes could be used, which could decrease the required modeling time in some cases. However, it would be best to vastly reduce or entirely remove the requirement for modeling expertise or effort.
  - Any attempt to decrease modeling time and expertise requirements, however, must not diminish the core capability of MPC, which is to produce controllers that are highly customized to the particular system and its context.
- Controller implementation: complexity and cost
  - The first two MPC projects also used a laptop to control the shading system (since focus was on evaluating the benefit of MPC, not implementation) and that approach is not scalable. Any practical solution must be demonstrable on a low-cost controls infrastructure, and ideally the logic must also be produced and embedded in a highly automated and low-cost manner.

We realized that the modeling structures produced in the initial studies are very flexible, and if packaged properly they can be reused and customized to work for a wide variety of cases. One added conceptual and practical step was necessary: automation of the controller construction process so that a non-expert user can configure their own controllers through a web interface and have the controller code exported to them to use on an embedded controller.

### *Outcomes*

In this project, a fully automated controller production system was set up for a motorized external venetian blind device. A web interface allows the user to specify some details of their particular building and window configuration, as shown in Figure 48. Upon submittal, a central server on the Amazon Elastic Compute Cloud (EC2) configures the necessary files and commands, and then opens various other virtual machines on EC2 and runs thousands of optimizations on them. Once the calculations are finished, the resulting lookup table and interpolation-based controller files are sent to the user by email. Depending on the control objective, the constraints options and the model parameters selected, the computation of the

large (2,450-point) lookup table may cost between \$5–\$20. The control logic is simple enough to be implemented on small and cheap distributed controllers, as shown in Figure 49.

**Figure 48: Screenshot of Website: Control Logic Constructor Inputs**

## Advanced Facades Control Logic Constructor

**Model Parameters**

37.872 latitude 122.272 longitude 120.0 st. meridian

**External view from window plane**

unobstructed, orientation: 0.0 (N=0,E=90,S=180,W=270)

**Facade system**

Nysan two-zone external blinds with 2-pane clear glazing

**Internal geometry and reflectivities**

common single-office layout

**Lighting system**  
(does not apply if controlling to maximize illuminance)

500.0 Desktop illuminance setpoint (lux)

100.0 Watts req. to meet desktop illuminance setpoint w/out daylight

0.15 d Watts / d lux : slope of dimming curve

**Thermal zone and HVAC**  
(does not apply if controlling to maximize illuminance)

21.0 Room air temperature setpoint (C)

4.0 Cooling system average COP

0.9 Heating system average efficiency

**Control Options**

**Constraints**

Use glare constraint  
If so, DGP threshold: 0.42

slat angle restricted to horizontal or downward

slat angle freedom of 180 degrees

**Objective**

Maximize illuminance

Minimize lighting + HVAC energy

**Conditions grid size**

Small grid (16 points) for process testing / reporting

Large grid (2450 points) for controller

**Output Options**

email address for files to be sent to: bricof@gmail.com

lookup table in csv format

python code to run controller on desktop

python code to run controller on Raspberry Pi

detailed process data for reporting

Source: Coffey et al. 2013a.

**Figure 49: Control Logic Constructor Outputs: (a) Desktop application; (b) Python code ready to be run on a Raspberry Pi, which can be embedded in a window unit**

Lookup Control Tester

directNorm 800

diffuseHor 200

dayOfYear 172

hour 12

shadePositionTop -70.0

shadePositionBotto 40.0

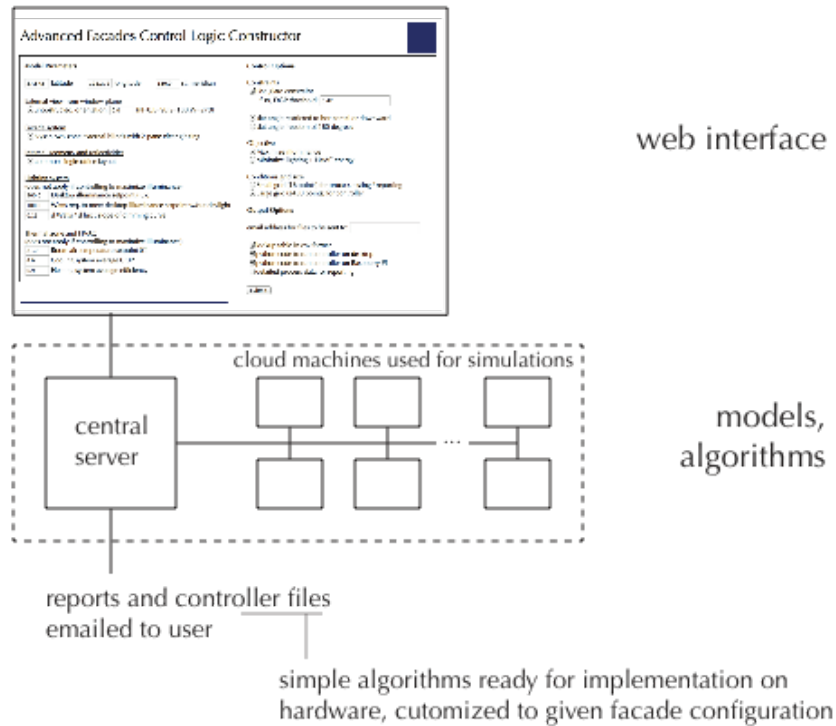


Source: Coffey et al. 2013a.

The overall process is shown in Figure 50. The web interface is simple, as are the control algorithms that come out the other end. In between is an automated process that encapsulates much of the work carried out in the initial tests of MPC described above. The first step in the automated process is to configure the underlying models according to the web user's specification. This means placing the desired shading system and geometries components within the structure of the dctimestep calculation, and setting the desired parameter values within the rest of the model components. If the web user specifies glare control as part of their

control configuration, then the next step carried out by the automated process is to calculate glare constraints on the shading positions over a broad range of solar conditions, as shown in Figure 51 (assuming the selection of horizontal-and-downward-only for two-zone venetian blinds). With these glare constraints in hand (or set to non-existent, if glare control is not specified by the user), the process then moves on to determining the optimal shade positions over a wide variety of solar and exterior temperature conditions. Some example results of the process are shown in Figure 52.

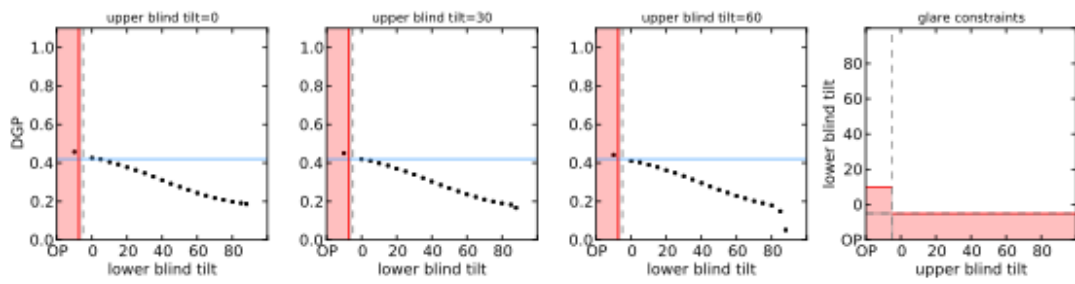
**Figure 50: Automated process overview**



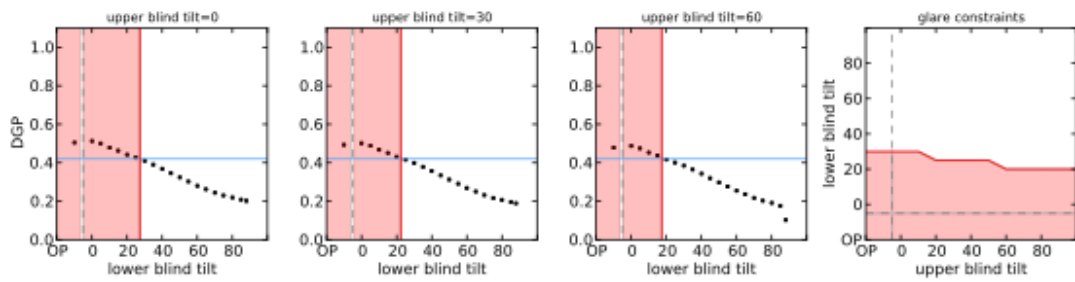
Source: Coffey et al. 2013a.

Figure 51: Glare constraints construction

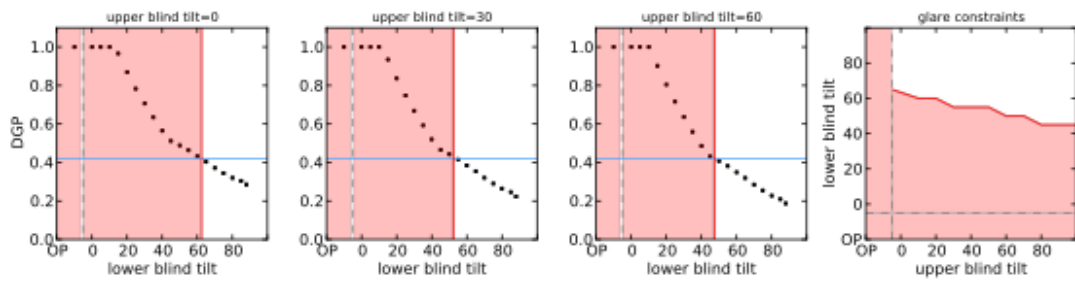
June 21, 9am



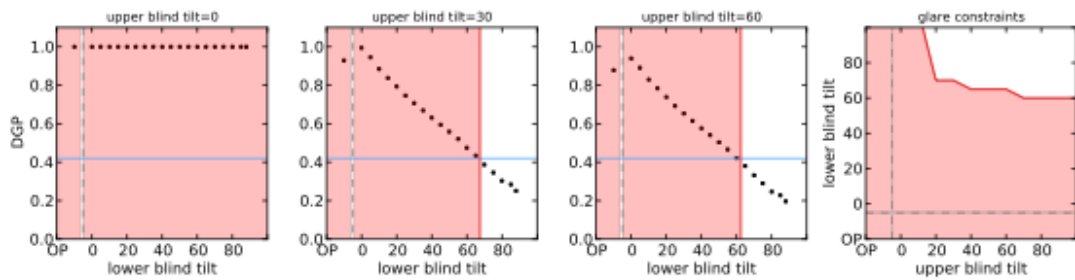
June 21, noon



Dec 21, 9am

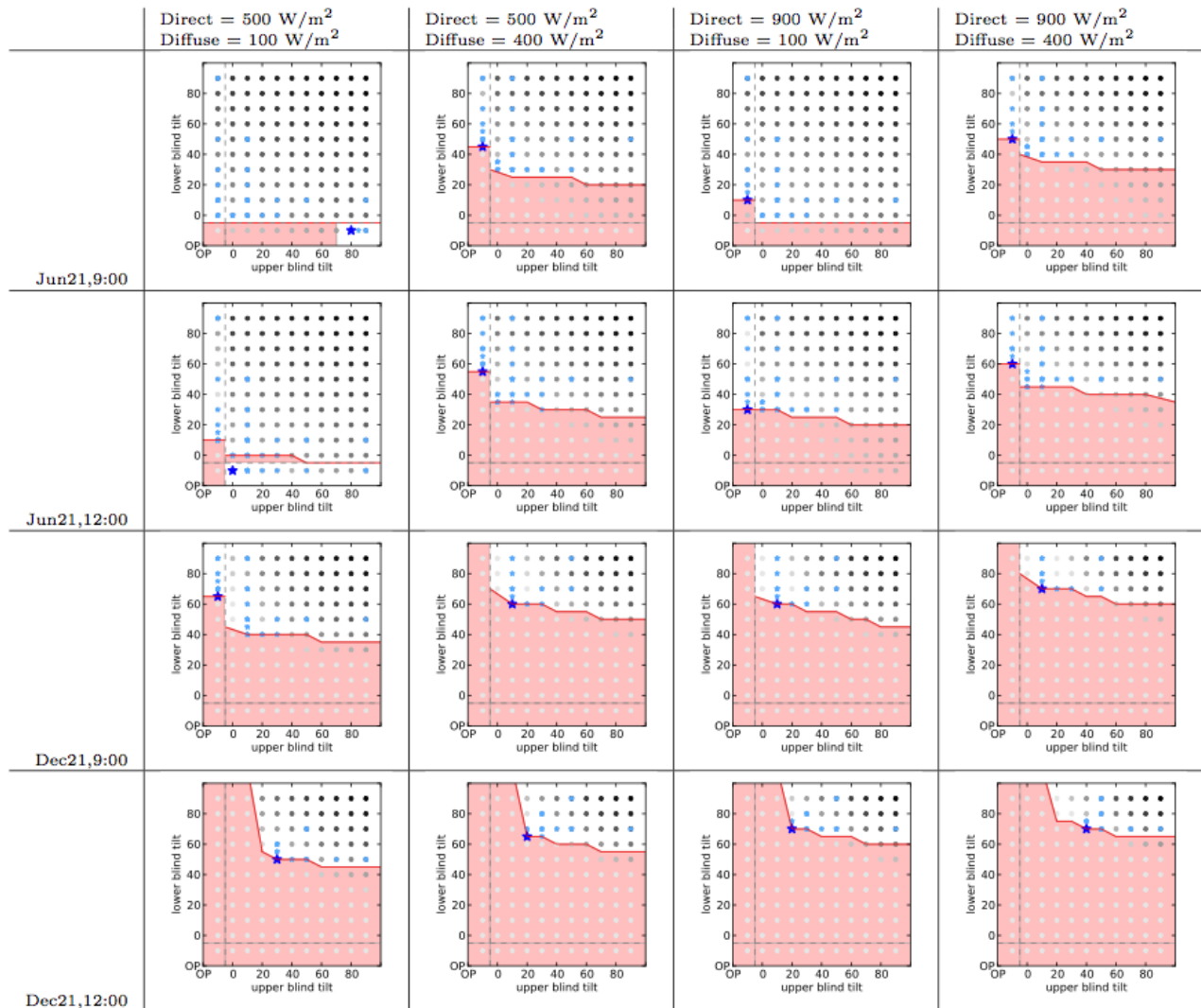


Dec 21, noon



Source: Coffey et al. 2013a.

**Figure 52: Example optimization results**



Source: Coffey et al. 2013a.

The resulting lookup table of optimal control positions is then combined with an interpolation algorithm in Python code that is emailed to the user, ready for implementation on their desktop or on a simple control platform.

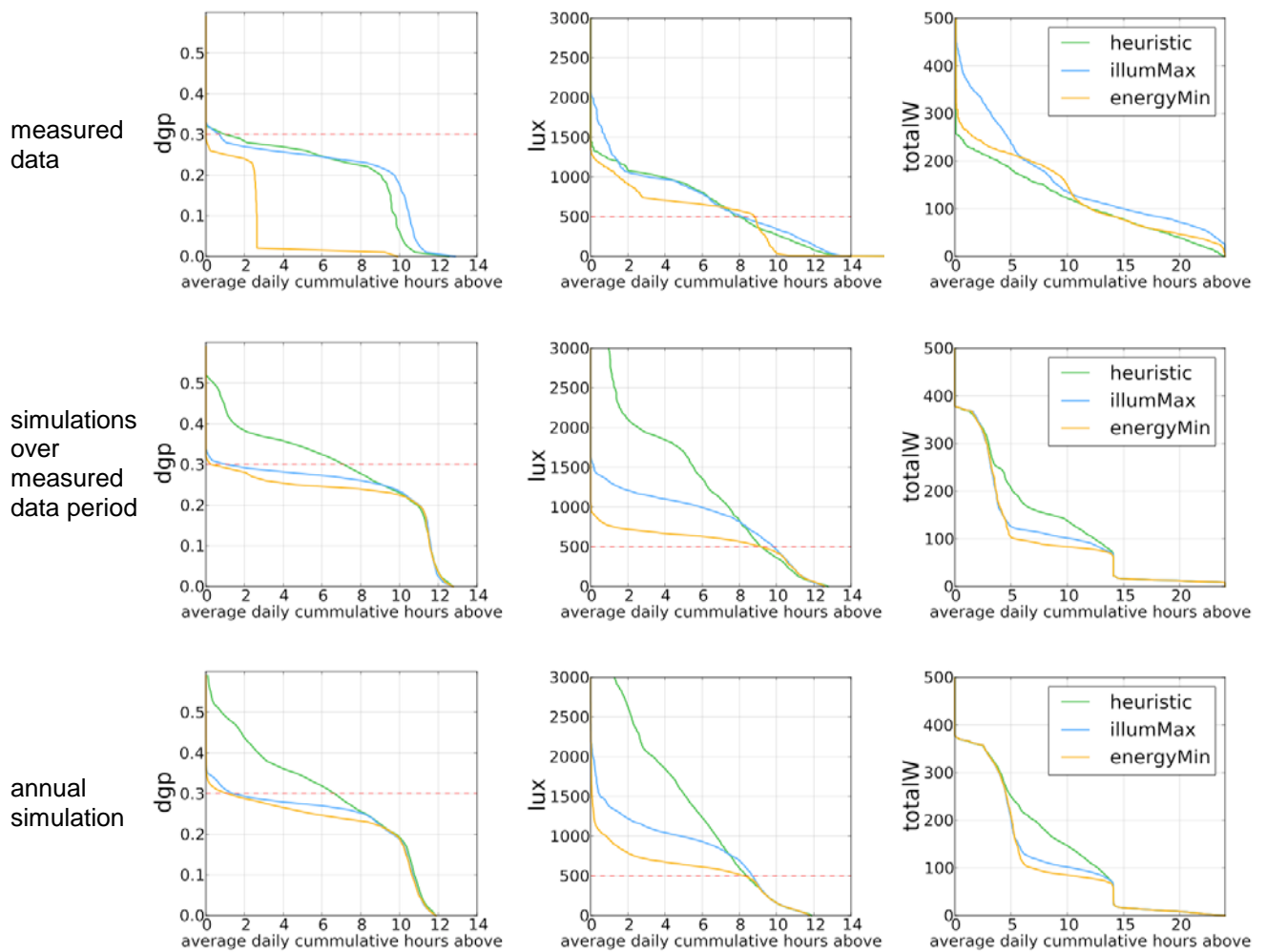
Many variants on this process are possible, including different types of shading systems, different orientations and different types of HVAC systems. Many variants are already included as options in the system, and others can be added to it without major changes to its underlying structure.

The performance of two model-based controllers produced by the automated web-based system have been compared to a heuristic controller (derived from a standard “block direct beam” control logic), both in annual simulations and in physical experiments with two-zone exterior



venetian blinds at the Advanced Windows Testbed, with the controller embedded on a low cost microcontroller (Raspberry Pi). One of the controllers (“illumMax”) is configured to maximize illuminance subject to glare constraints (essentially repeating the case study in Subsection 4.2.2, but with automated offline approximation of MPC, rather than online optimization), while the other controller (“energyMin”) is configured to minimize the combined lighting and HVAC energy without glare constraints (building upon the case study in Subsection 4.2.3 but using a two-zone blind configuration and considering the trade-offs between lighting and HVAC savings, and assuming negligible thermal mass). Figure 53 shows some of the cumulative results. In annual simulations, the illumMax controller results in a 76 percent reduction in the incidence of DGP > 0.30 while still providing adequate workplane illuminance levels, and the energyMin controller provides an 18 percent reduction in combined lighting plus HVAC energy.

**Figure 53: Cumulative performance comparison of heuristic and app-constructed controllers**



Source: Coffey et al. 2013a.



The physical testing at the Advanced Windows Testbed allowed us to demonstrate the feasibility of the web-to-controller process. It also allowed us to investigate other potential practical considerations with the controller. Because the controller often finds precise optima in areas with steep performance gradients, it is sensitive to small errors both within the control logic (primarily because of interpolation) and in the shading device actuation (the motor turning accuracy is usually within  $\pm 5$ – $10$  percent). Some changes to the MPC configuration were made to account for this, but further engineering could help its performance. Similarly, the controller performance in the physical tests was insensitive to quick changes in direct/diffuse because of cloud movements, because we had placed a restriction on its movement to just once per 15 minutes, in order to avoid wearing out the blinds motor or causing excessive noise. Improving the blinds hardware to allow for more frequent changes in shade position would thus facilitate better performance with these advanced controllers, or, conversely, the controllers could use predicted direct/diffuse values over the control timestep instead of the simple measured values at the start of that timestep. The control (which is currently exclusively open-loop) could also be improved by augmenting it with feedback, if the appropriate sensors are available. The lookup table interpolation could be used to find an appropriate starting point for the two-zone blind positions, and a local-loop control could be used to modify those positions to avoid glare or to decrease lighting or HVAC power consumption.

Currently, the app-produced controllers require four (or five in the case of energyMin) inputs: day of year, time of day, direct normal radiation, and diffuse horizontal radiation (and outdoor temperature, in the case of energyMin). It is questionable if the direct/diffuse split can be assumed to be readily available as a sensor reading. Further research could look into how much performance would be lost with less accurate estimations, potentially allowing for the use of different and/or lower cost sensors.

As noted above, this cloud-based automated structure can be easily extended to incorporate other system or control options. The following options are slated for inclusion in the very near term:

- Considering electrochromics is simply a matter of including a set of BSDFs and an absorption matrix appropriate to a particular electrochromic window system.
- Thermally massive HVAC systems can be considered by incorporating the reduced-order Java model and associated Simplex algorithm discussed in Section 4.2.5.
- Demand-response signals and/or time-of-use pricing can be incorporated into the system by making relatively simple adjustments to the objective function for the energy minimization control option.

Other options could also be included, such as allowing the users to upload CAD file descriptions of their interior and exterior geometry, or including considerations such as building-integrated photovoltaics (PV), phase change material (PCM) or battery storage.

One of the enabling tasks of this research was the development of a set of Python methods to speed up the model-based controller development process when using building simulation

modeling platforms (e.g., EnergyPlus, Modelica). This includes Python methods that encapsulate the offline-optimization approximated MPC techniques described above, which we feel are of particular utility for dynamic façade controllers. These methods have been brought together in a Python library called BSAT (Building Simulation-based Analysis Toolbox). They have been given a user interface to help guide practitioners—who may or may not be Python savvy—through the process of performing parametric analysis, optimization (with GenOpt or with Python libraries), and parametric optimization (as used in offline-optimization approximated MPC) and/or related processes (e.g., calibration, Monte-Carlo analysis). They ultimately guide them through the production and export of online MPC controllers or offline approximations of such controllers. The Python library has proven useful in the development of the cloud-based dynamic façade controller production app described above, and it is generic enough that we hope it will also be useful to researchers, consultants, analysts, and designers more generally, in part for the production of other cloud-based apps like the one described above.

We have been discussing the ideas around this cloud-based controller-production app with California-based companies and organizations. There are various ways that it could find its way into practice. It could be used by façade assembly companies to produce customized near-optimal control for their integrated units. It could be used by shading system companies or by building designers. It could also be used by the growing community of companies, many of whom are California-based, that provide web-based information management platforms for buildings with the intent of improving their operations.

## **4.3 Dynamic Façade Component R&D**

### **4.3.1 Switchable Thermochromic Windows**

#### *Approach and Goals*

As indicated in Section 4.1, thermochromic (TC) windows are starting to emerge on the market, but very little is known about how these devices affect the energy performance and indoor environmental quality in buildings. Thermochromic materials transition from a clear, cold state to tinted, hot state at a “critical temperature” or range of temperatures that is inherent to the material’s fundamental chemistry and makeup. Unlike thermotropic materials, which are translucent when switched, thermochromics maintain a transparent view irrespective of their switched state. These materials have been and continue to be developed for window applications as a means of passively controlling solar heat gains in buildings and as a low-cost alternative to electrochromic windows. The concept is to transmit solar radiation through the cold, untinted window in the winter (to reduce heating energy use requirements) and absorb then reject radiation with the hot, tinted, low-e window in the summer (to reduce cooling energy use requirements). Control of solar heat gains in this manner has the potential to reduce building energy use and peak electric demand, assuming that the switching response of the thermochromic matches the typical heating and cooling demand profiles of residential and commercial buildings.

Quantifying the energy-efficiency benefits of this technology at the proof-of-concept stage is hindered by a number of technical barriers. The spectral properties of TC prototypes must be fully characterized under a range of thermal conditions, so the prototype must be sufficiently stable and durable. Simulation tools must be modified to accept these data in order to model building energy performance. Field verification by way of calorimetry, mockups in outdoor testbed facilities, or installations in occupied buildings require large-area prototypes, so the prototype must be at minimum in the fabrication stage of maturity.

A detailed investigation was conducted to determine the technical potential of a polymer-based, ligand exchange thermochromic window (Pleotint, Inc.) for internal load-dominated commercial building applications. The film transitions from an untinted clear to dark tinted phase over a range of critical temperatures between approximately 24°C–75°C (75°F–167°F). The film can be produced using roll-to-roll processing techniques in large areas and is designed to be used as an interlayer in a laminate configuration within a low-e insulated glass unit (IGU).

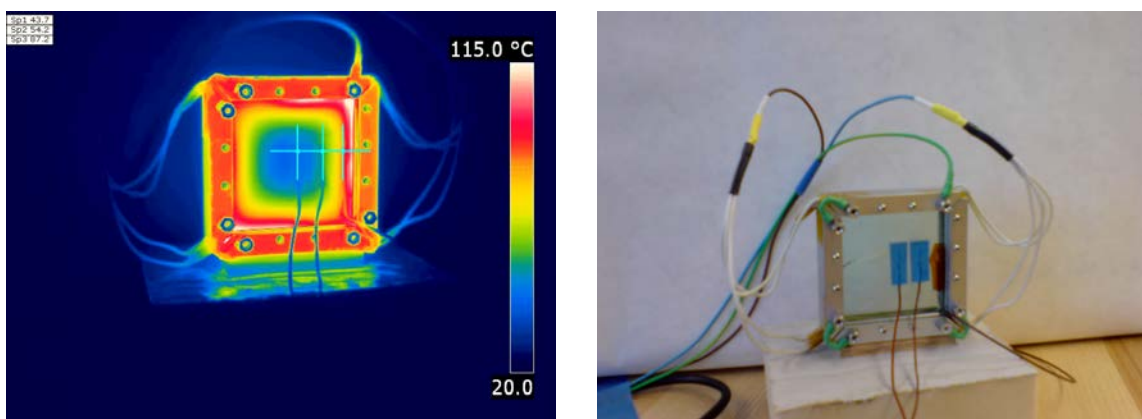
The approach involved developing the methods to measure the solar-optical properties of the switchable device using conventional spectrophotometers, building the simulation tools needed to model the energy impacts of the windows (Optics, WINDOW, and EnergyPlus), characterization of how large-area thermochromic windows switch under real-world outdoor conditions, and an assessment of annual energy savings potential in hot and cold climates using EnergyPlus.

#### *Outcomes*

There were several outcomes that were of benefit not only to the partner manufacturer but to the thermochromic window community at large.

First and foremost, the tools needed to characterize and model the energy impacts of thermochromic windows were developed and incorporated in public releases of WINDOW 6.3.9 and EnergyPlus 7.0 software (Curcija and Jonsson 2011; Hong 2011). Because thermochromic glazings switch based on temperature, an alternative measurement procedure was developed so that the transmission and reflectance properties of the samples could be measured at elevated temperatures (Figure 54). Modifications were also made to EnergyPlus. The software now calculates the heat balance of the thermochromic window to determine the surface temperature of the thermochromic layer, then uses this temperature to determine the thermochromic switching state in the next timestep.

**Figure 54: Image of a heated thermochromic sample**



A framing structure incorporating a heating element was built to hold the glazing sample at the edges. The sample is heated and allowed to equilibrate over a 30-minute period, then the entire assembly is inserted into the spectrophotometer and measured at 5 nanometer (nm) increments over the 0–2500 nm range, with each incremental measurement taking approximately 5 minutes.

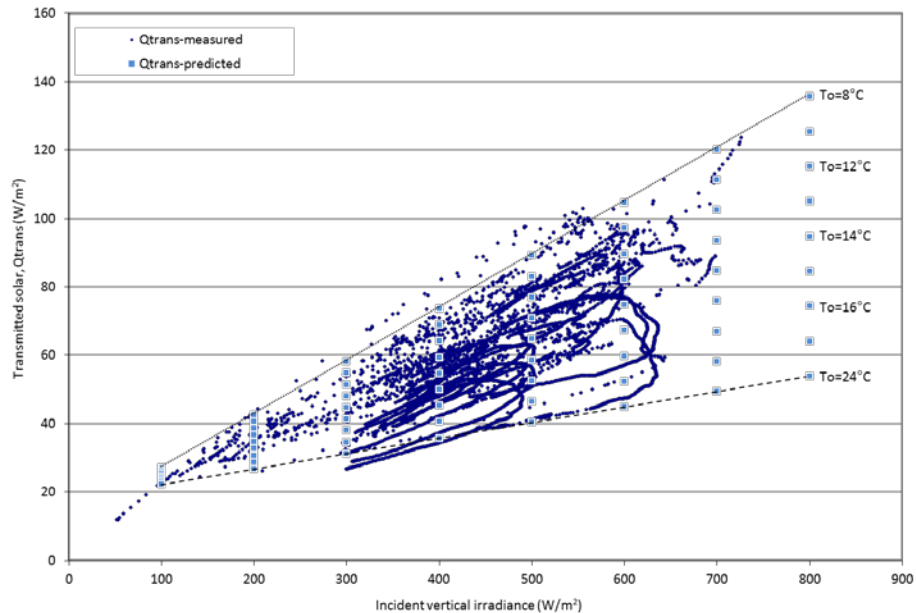
Source: LBNL.

To better understand how the thermochromic actually worked, a large-area thermochromic window was installed in the LBNL Advanced Windows Testbed and monitored over a solstice-to-solstice period. Detailed measurements were made to characterize switching performance under variable outdoor conditions. Measured and simulated data were related to the perimeter zone heat balance and energy use for an internal load-dominated office zone to illustrate how thermochromic properties affect HVAC energy use. Observations were made in the field concerning the appearance of the thermochromic window when the incident irradiation was non-uniform and of its ability to control discomfort glare.

The installed polymer TC windows had a broad switching temperature range and so exhibited a uniform tinted appearance even though there were times when the distribution of radiation and consequently the temperature gradient across the window was non-uniform. For example, a temperature gradient of 10°C–13°C (18°F–23°F) occurred over a 80-centimeter (cm) wide area due to local shading by the window frame, but no discernible difference in tinting was visible when viewed from the indoors or outdoors. The window maintained a transparent, undistorted view across its switching range.

The windows were demonstrated to switch as a function of both outdoor air temperature and solar irradiance (Figure 55). This is generally known but may not have been clearly relayed to material scientists who may be striving to develop new materials to switch at a critical temperature of 24°C (75°F), which has been defined by an ambient air temperature that people generally find comfortable.

**Figure 55: Monitored transmitted solar radiation (W/m<sup>2</sup>) through the thermochromic window**



Predicted and measured transmitted solar radiation,  $Q_{trans}$ , through the clear thermochromic window as a function of incident vertical irradiance and outdoor dry-bulb temperature,  $T_o$ . Predicted values were derived from field-measured data for a south-facing window in a conditioned testbed office for test days from April 1 to May 19.

Source: Lee et al. 2013.

Using EnergyPlus, annual energy savings due to the thermochromic window in the south, east, and west perimeter zones of a prototypical large commercial office building were found to be slightly greater than an advanced low-e dual pane window but less than a triple-pane low-e window in hot/cold and hot, humid climates. Whole window properties of the dual-pane clear thermochromic window modeled in this EnergyPlus study were  $T_{vis} = 0.22-0.03$  and  $SHGC = 0.31-0.16$  for a glass temperature range of  $24^{\circ}\text{C}-75^{\circ}\text{C}$  ( $75^{\circ}\text{F}-167^{\circ}\text{F}$ ). Note that the impact on daylighting and lighting energy use was not determined. More detailed information can be found at (Lee et al. 2013).

### 4.3.2 Near-infrared Switching Thermochromic Windows

#### *Approach and Goals*

Developing thermochromic materials that maintain a high visible transmittance (i.e.,  $T_{vis} = 0.50-0.70$ ) while modulating the solar infrared is desirable from the perspective of solar control, daylighting, and indoor environmental quality (for perception of brightness and connection to the outdoors). Current broadband thermochromic windows will negatively affect daylighting and lighting energy savings, although they may improve visual discomfort if there are no direct views of the sun. There are worldwide research efforts directed toward the development of such near-infrared, narrowband thermochromic devices (Granqvist et al. 2010; Li et al. 2011).

Having developed the capabilities to model thermochromic windows, it was possible to conduct an EnergyPlus parametric study to determine which switching properties were desirable, and if achieved with advances in material science, how much energy would be saved above and beyond commercially available, advanced low-e windows with operable interior shades. The study was designed to provide developers with guidance on the ideal critical switching temperature range given a hypothetical NIR thermochromic (solar transmittance,  $T_{sol} = 0.10-0.50$ ,  $T_{vis} = 0.30-0.60$ ).

#### *Outcomes*

The hypothetical thermochromic was modeled with four different ranges of critical switching temperatures to determine its effect on energy use for a prototypical office building in a hot/humid and hot/cold climate. The lowest switching temperature range (14-20°C) was found to result in lowest total perimeter zone energy use in a prototypical large office building. Annual energy use savings were between 3-17 percent compared to commercially available, near-IR selective low-e windows ( $T_{vis} = 0.64$ , SHGC = 0.30, U-value = 1.35,  $K_e = 2.13$ ) with the greatest savings occurring in the south-, east-, and west-facing perimeter zones with large-area windows in hot climates.

Significant research will need to be carried out in order to achieve the characteristics proposed in this study. If the hypothetical thermochromic window can be offered at costs that are competitive to conventional low-e windows and meet aesthetic requirements defined by the building industry and end users, then the technology is likely to be a viable energy-efficiency option for internal load-dominated commercial buildings. More details can be found at Hoffmann et al. 2013).

### 4.3.3 Near-infrared Switching Electrochromic Windows

#### *Approach and Goals*

Similar to the near-infrared thermochromics, electrochromic devices that exhibit narrowband switching in the near infrared could maintain daylight in indoor spaces while controlling solar gains. Such devices would also exhibit minimal changes in color, which could meet the aesthetic requirements of architects and homeowners who desire a clear, transparent façade.

Near-infrared switching electrochromic devices were suggested in Selkowitz et al. (1994), and a new effort was initiated in 2012 at LBNL's Molecular Foundry to develop such a device given advances in electrochemical doping with nanostructured materials.

To provide guidance to the material science team and determine the energy- and carbon-reduction potential of such a technology, a parametric simulation study using COMFEN, a front interface to EnergyPlus (see Section 5), was conducted to determine regionally dependent solar-optical performance thresholds below which NIR-switching electrochromic windows would be competitive to advanced, spectrally selective windows.

## *Outcomes*

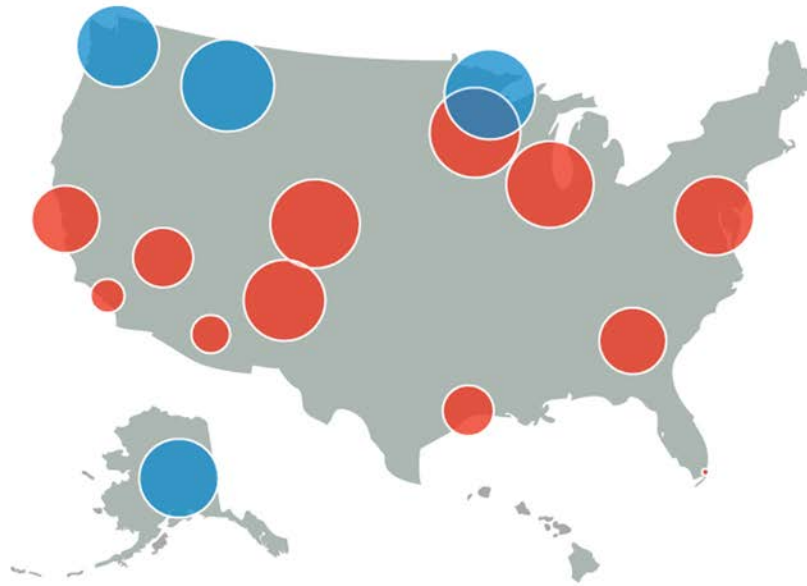
Energy simulations were performed for a prototypical commercial office building and residential home in 16 representative U.S. climate zones, including Los Angeles and San Francisco. The clear and tinted state of the electrochromic window was defined by the properties of commercially available spectrally selective windows with a maximum solar and daylight switching range of SHGC = 0.65–0.30 and  $T_{vis}$  = 0.78–0.69, respectively. Annual energy simulations were run separately for each of the two end states and then post-processed to determine for each timestep the optimal switching state that resulted in the least energy use. This simplification did not account for the room heat balance, but this was considered to have minor impact on the results of the study. Daylighting controls for the electric lighting were included in the analysis, but visual discomfort was not included as a performance criterion.

For the broadest applicability across all markets and climates, the study found that the electrochromic with the broadest switching range and lowest minimum SHGC resulted in lowest energy use for both building types. The solar-optical performance thresholds were found to be greater for residential homes than for commercial offices: internal load-dominated commercial buildings require greater control of solar loads to minimize energy use, so the number of qualified switching options was less. Annual source HVAC energy savings were significant across all climates for residential applications and in northern climates for commercial applications. For example, savings were 8.5 kWh/m<sup>2</sup>-yr (0.79 kWh/ft<sup>2</sup>-yr) or 25 percent for residential applications and 1.8 kWh/m<sup>2</sup>-yr (0.17 kWh/ft<sup>2</sup>-yr) or 7 percent for commercial applications in San Francisco (Figure 56). Details can be found at (DeForest et al. 2013).

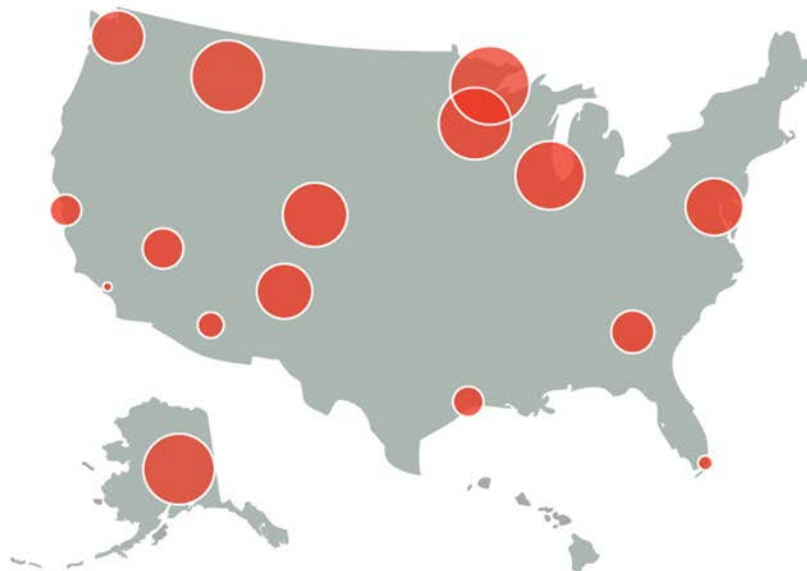
The material science R&D effort resulted in a demonstration of the feasibility of NIR-selective plasmonic electrochromic coatings (Garcia et al. 2013; Milliron 2013). Heliotrope Technologies, Inc. in California was founded based on the research and is currently working to bring the initial prototype to the market.

**Figure 56: Residential and commercial source HVAC energy use intensity (EUI) savings from highly dynamic electrochromic glazings compared to optimal static technology**

**Residential Results**



**Commercial Results**



**Competing Static Technology**  
 ■ High solar gain low-e  
 ■ Spectrally selective (blocking) silver

The color of the bubble indicates which optimal static technology the savings were determined from (either a high-gain, high-transmittance low-e window in the cold climates or a solar control low-e window in the moderate to hot climates). The diameter of the bubble indicates the magnitude of savings.

Source: DeForest et al. 2013.



## 4.4 Monitored Demonstrations

### 4.4.1 Pilot Demonstration of Sage Electrochromics in Washington, D.C.

#### *Approach and Goals*

The U.S. Department of Energy's Emerging Technologies Program supported a pilot demonstration of Sage Electrochromic windows in 2010 in order to experience firsthand the work needed to retrofit a building with this technology and witness how the technology performed in their day-to-day working environment. The technology was an emerging product: the tungsten-oxide switchable devices were modulated automatically between either the fully clear or fully tinted transparent states to control solar gains, daylight, and discomfort glare. Later, Sage added the capability to modulate the windows between four different tint levels.

The electrochromic (EC) windows were installed with advanced, thermally improved window frames and a dimmable lighting system in a single, west-facing conference room in Washington, D.C. (Figure 57). The logic of the controller was heuristic, based on if-then statements to determine the mode of control (schedule, occupancy, heating or cooling season), then open-loop control for modulating daylight and glare based on defined threshold levels. Occupants were able to manually override the automated controls. The system was monitored over a 15-month period under normal occupied conditions, where the last six months were used in the analysis. Manual override data were analyzed to assess the EC control system design and user satisfaction with EC operations. Energy and comfort were evaluated using both monitored data and simulations.

**Figure 57: Interior view of the conference room with upper and lower control zones**



Source: Lee et al. 2012.

### *Outcomes*

Results from the monitored study indicate significant energy savings, good end-user acceptance of the automated systems, and increased comfort and access to outdoor views. Weekday lighting energy use savings were 91 percent compared to the existing lighting condition with no lighting controls. Annual total energy savings were estimated to be 39–48 percent compared to the existing window and lighting condition, which met the ASHRAE 90.1-2007 level standards except for the higher window U-value. Summer electric peak demand was reduced by 22–35 percent.

Manual overrides of the automated system were indicative of how well the system met the end-user requirements. Of the 328 meetings that occurred over the six-month period, the manual switches were used during 14 (4 percent) of these meetings for reasons other than demonstration of the EC window technology. We inferred from the way the system was overridden that the end users desired more daylight while mitigating discomfort glare. The blinds were lowered occasionally over the upper window zone during some of the monitored period, possibly to reduce the luminance contrast between the upper clear zone and the lower tinted zone. The case study is documented in Lee et al. (2012).

#### **4.4.2 Post-occupancy Evaluation of Dimmable Lighting, Automated Shading, and Underfloor Air Distribution System in The New York Times Building**

##### *Approach and Goals*

The DOE Commercial Buildings Partnership Program funded a post-occupancy monitored evaluation of the New York Times Building in 2012. The Times portion of the 52-story, 1.5 million square foot, high-rise building uses automated roller shades, dimmable lighting, and an underfloor-air distribution system—the former two of which were developed specifically for the building using the latest technological advances at the time. The evaluation was conducted over a one-year period about five years after the building was occupied in 2007 to determine actual energy savings and end-user response resulting from these systems.

Lighting energy-use savings due to the different control strategies (scheduling, occupancy, setpoint tuning, daylighting) was determined using power metering of the circuits in combination with lighting control data over a full year. Heating, ventilation, and air conditioning energy use savings were determined using a tuned EnergyPlus model using monitored data to characterize HVAC component efficiency, equipment lighting, occupancy loads, and shade position. The complex fenestration modeling tools described in Chapter 3 were used for the analysis. A survey was issued by The Times to all employees independent of LBNL, and the resultant data was later conveyed to LBNL for analysis. There were 665 respondents to the survey (a 35 percent participation rate).

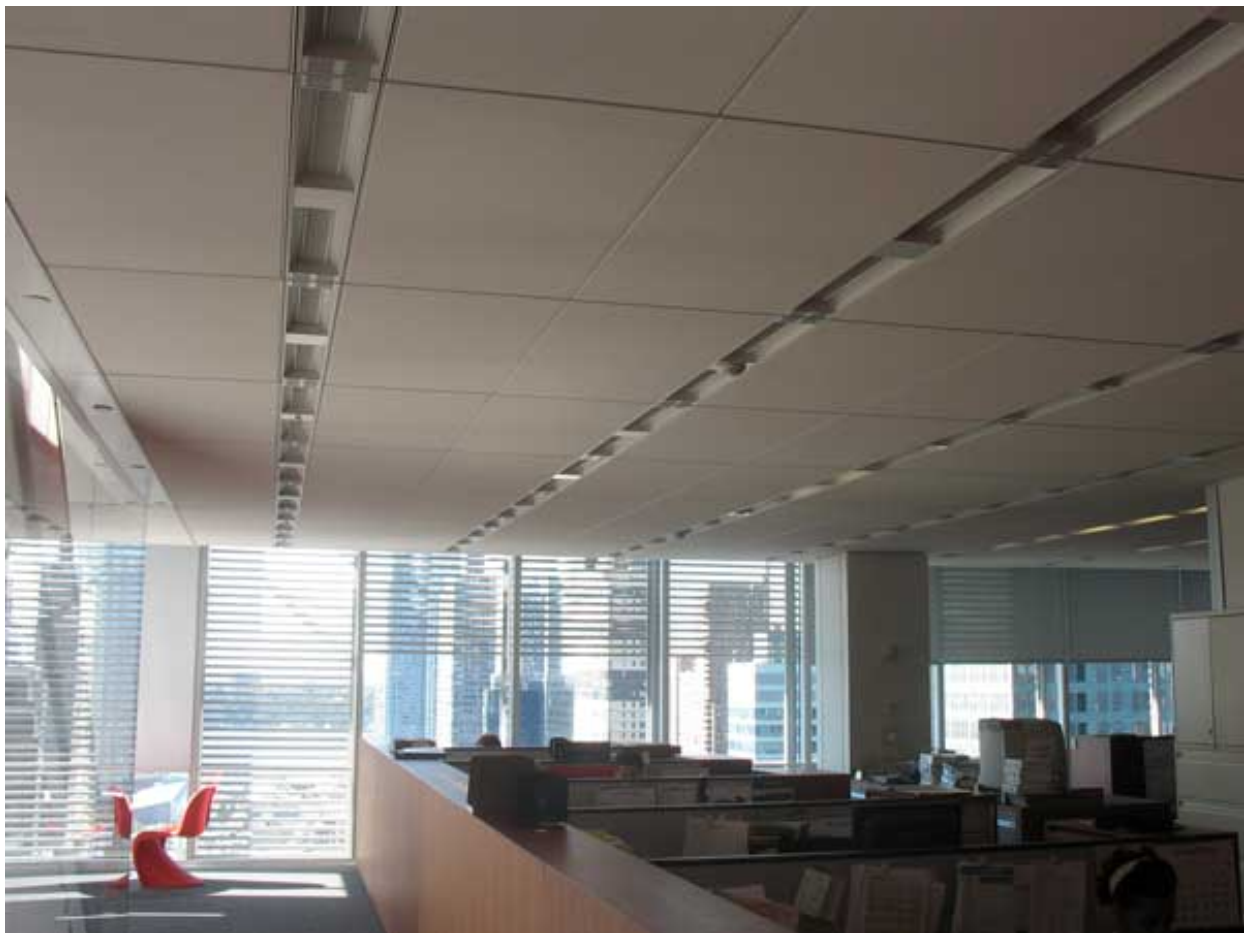
##### *Outcomes*

Measured results in the final building showed a 24 percent reduction in annual electricity use and a 51 percent reduction in heating energy use, compared to expectations from a design that just met the prescriptive energy-efficiency code in effect at the time of construction (ASHRAE

90.1-2001), and a 25 percent reduction in peak electric demand. In addition, a significant fraction of occupants indicated a high level of satisfaction with the overall building and its design features. The Times Company's investment in advanced energy-efficiency technologies is estimated to yield a 12 percent rate of return on their initial investment (Figure 58).

Years prior, during the building's design phase, new aspects of the automated roller shade control system were developed by MechoSystems through a 12-month monitored study in a full-scale mockup of a portion of the Times Building tower, with involvement from LBNL and the New York Times Company. The critical aspect of control was knowing when to lower the shade to mitigate discomfort glare and when to raise the shade to admit daylight and permit unobstructed views out.

**Figure 58: Interior view of the Times Building**



Interior view of the Times Building five years after occupancy. The overhead lighting is dimmed in response to available daylight, while the automated shades are adjusted to control for glare and direct sun. The underfloor air distribution system maintains comfortable conditions in the lower occupied zone of the space, saving on air conditioning energy. These three measures resulted in a 24 percent reduction in annual energy use and a 51 percent reduction in heating energy use compared to the prescriptive energy-efficiency code in effect at the time (ASHRAE 90.1-2001). They were estimated to yield a 12 percent rate of return on the initial investment.

Source: The New York Times Company.

Results evaluating occupant satisfaction with the shades' operation were mixed. The post-occupancy evaluation included issuance of a survey to which a large number of the occupants responded (n = 665, 35 percent of the total). While manual override of the automatic shading system occurred infrequently for the majority of the motors (80 percent overridden an average of 18 times per year), the remaining 20 percent of the occupants overrode the shades an average of 29 percent of the year, with most actions taken to lower the shade. Of the 316 comments received concerning the shades, however, 206 (65 percent) of them were related to visual discomfort due to the window shades and/or their operation. Some of this could be attributed to improper control settings (the shades were raised 30 minutes before the sunset so that occupants could see the sunset; unfortunately, this was the worst condition for glare). The shade fabric was also known to control direct source glare insufficiently, so dissatisfaction could have been due to the fabric and not the controls. The survey, which was developed and issued by others, not LBNL, unfortunately did not specify whether perceived glare was due to the overhead electric lighting or the windows, thereby confounding the analysis.

The overall indoor environmental quality resulting from the architectural design, layout and selection of furniture and finishes, and use of the automated shading and dimmable lighting was found to be very satisfactory by the majority of the occupants, and contributed to their ability to get their job done. Seventy-eight percent of the occupants were satisfied with the overall quality of the lighting in their workspace (an average rating was 5.53 on a scale of 1–7). Sixty-one percent of occupants believed that the new building enhanced their ability to get their job done (the average rating for all floors was 5.02, where 4 is “neutral”). Both questions were significantly correlated to overall satisfaction with the building.

By combining informed design, efficient technology, and properly integrated building systems, carried from design to construction and commissioning and into operations, this study demonstrated that office buildings in an urban environment can deliver measured energy performance that substantially surpasses energy codes. The lesson for replicating the success of this building on a large scale is that the technologies and systems solutions are available, but that it is essential to pay attention to details from the initial stage of procurement of building equipment to verifying the proper performance of the equipment after it is installed. During construction and after occupancy, the Times Company facilities staff took the time to make sure the building was constructed according to design intent, and they commissioned the building before its opening—testing and adjusting the building's systems to ensure that they were performing properly. After the building opened, they continued to monitor the building's operation and made small adjustments to improve performance. The study is documented in (Clear 2010; Lee et al. 2012; Fernandes et al. 2013).

#### 4.4.3 Design Development of Automated Shading for the Health Sciences Biomedical Research Facility II at the University of California at San Diego

##### *Approach and Goals*

The University of California at San Diego (UCSD) invited LBNL to provide design assistance on their new Health Sciences Biomedical Research Facility 2 at the early stages of programmatic planning in 2008. Lawrence Berkeley National Laboratory's participation between 2008 and

2013 was funded by the PIER program. Objectives were to work with the proactive and engaged design team and the campus Facilities Design and Construction staff to achieve aggressive energy-efficiency goals in a laboratory building. The campus engineer stated that the labs should be 100 percent daylighted with minimal dependence on electric lights during the day and that window heat gains should be minimized to reduce the capacity and therefore capital cost of the HVAC system (even though there was a 100 percent outside air requirement).

From the very start, the design team considered fixed and automated exterior shading. Modeling tools were needed to determine the life-cycle cost benefit of the technology and avoided CO<sub>2</sub> emissions, which was a key metric that UCSD used to evaluate progress toward their campus goal of achieving zero net energy use and sustainability.

Several measures were considered, including lab area daylighting and solar gain control through operable exterior louvers. Zimmer Gunsul Frasca (ZGF) Architects relied on the limited simulation tools available at the time to work out how the blind should be best configured (e.g., indoor blinds for upper window, outdoor blinds for lower window, etc.). Window heat gains were determined using EnergyPlus and later COMFEN, where the exterior shading systems were assumed to have matte diffusing surface properties. The operable venetian blinds were modeled using separate runs of COMFEN and then post-processed to determine the best blind position and slat angle to minimize energy use. Radiance point-in-time simulations were conducted by the Integrated Design Lab, University of Washington; the three-phase method for evaluating annual daylighting performance had only begun to be developed at LBNL. Despite these barriers, ZGF reached consensus with UCSD that automated exterior venetian blinds were worth the investment and a significant volume purchase was made to install the technology on 2,789 m<sup>2</sup> (30,000 ft<sup>2</sup>) of the east, south, and west façades.

Lawrence Berkeley National Laboratory continued to provide technical expertise pertaining to the automated shading system after the decision to use this technology in the building was made. The University of California, San Diego, was also informed of the monitored field test results of automated exterior shades from Phase I of this project. As our work on controls R&D matured, UCSD was introduced to the concept of model predictive controls. The campus engineer then allowed LBNL to develop a detailed case study to determine the potential benefits and drawbacks of this alternate mode of control.

### *Outcomes*

Construction of the new building was completed at the end of 2013 (Figures 59 and 60). The final building façade was designed with a 3 m (10 ft) deep overhang that subdivided the window into upper clerestory and lower view sections. An automatically controlled motorized exterior venetian blind (by WAREMA) was installed in both the upper and lower windows and controlled independently. Manual switches allow the end user to override the position of the shade for a limited preset period.

The campus engineer designed the automated shading system to address very pragmatic constraints. Detailing of the physical system and its operation were designed to minimize the cost of maintenance and operations, since UCSD had a minimal budget to cover such expenses

once a building was constructed (e.g., access for cleaning and repairing the motors, corrosion resistance from the salt in the marine air). A mockup of the shading system was set up on a nearby existing building over a period of two years to assess corrosion resistance of the shading system itself.

**Figure 59: Interior view of a typical daylit laboratory**



Source: LBNL.

The pragmatic approach included the control algorithm. Initially, the campus engineer considered engaging the staff at UCSD to develop the automatic control system so that long-term maintenance of the system could be conducted without reliance on outside vendors. The logic would also be completely transparent and therefore easy to modify if needed. Based on engineering calculations, the campus engineer defined a seasonal control sequence for the upper and lower blinds to shade the glass from direct sun. The blinds were to be fully raised or lowered to satisfy this objective and when lowered, the slat angle was to be set using the Warema system to block direct sun. Adjacent buildings that would otherwise shade the façade were accounted for in the controls. In the end, UCSD relied on the controls vendor to deliver a warranted, fully commissioned system that met these general control objectives and also addressed other safety concerns such as wind and fire that could damage the blinds.



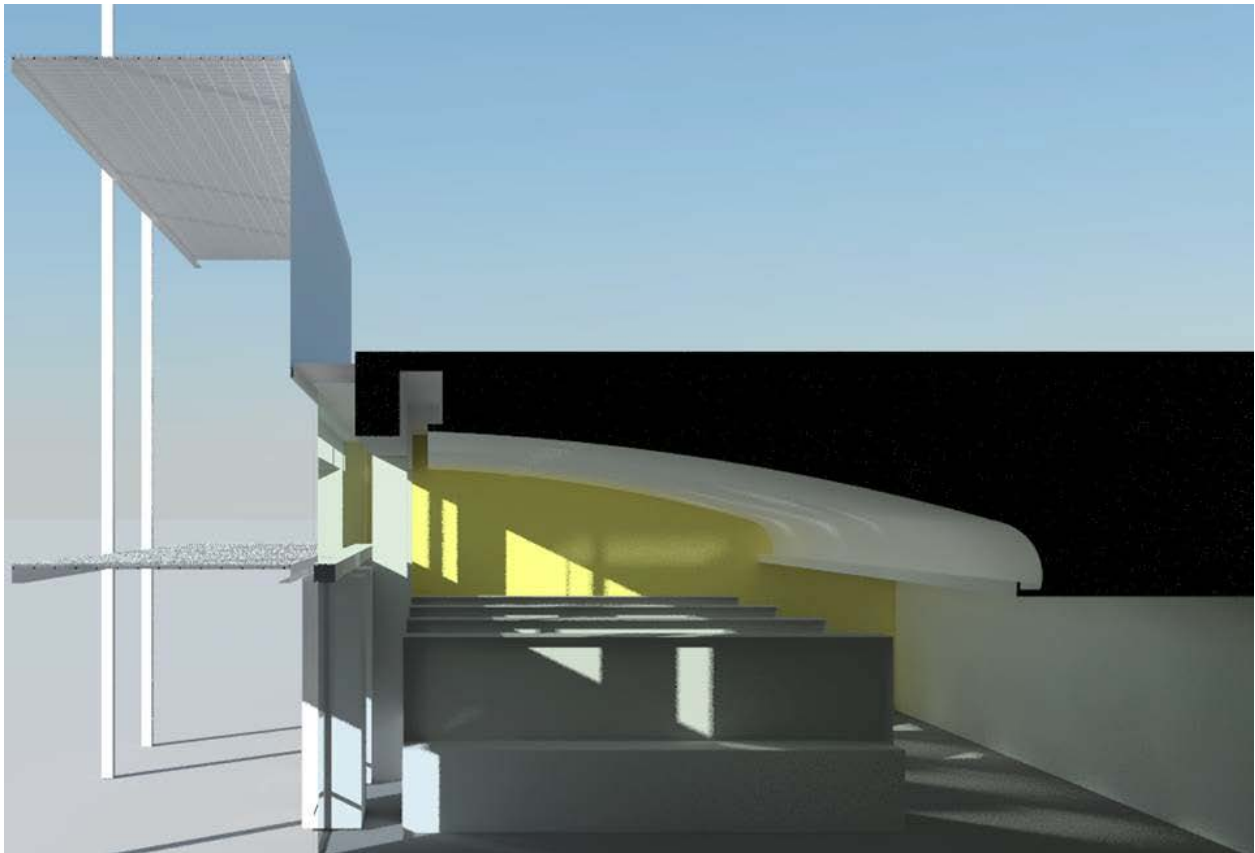
**Figure 60: Exterior view of a typical daylit laboratory**



Source: LBNL.

To determine the potential benefit and feasibility of model predictive controls, UCSD gave LBNL permission to use the existing Radiance design models (Figure 61) to generate the optimized control responses for the blinds. Methods described in Section 4.2.6 were used to create the responses. Visualization of the various modes of control over the range of environmental conditions provided the owner with some level of comfort on what to expect from this optimized control.

**Figure 61: Radiance model of laboratory space**



Source: LBNL.

Implementation in the final building was not possible before the completion of construction with the shade vendor due to contractual concerns. Because the building is heavily instrumented and metered, UCSD may consider a test comparing the performance of the existing and MPC modes of control between two floors at some later date after the building has been occupied.

#### **4.4.4 Monitored Assessment of Daylighting and Manually Operated Shading Systems in the New San Francisco Federal Building**

##### *Approach and Goals*

In late 2006, the program manager of Region 9 of the U.S. General Services Administration requested that LBNL conduct a preliminary evaluation of the daylighting and window brightness in the new, naturally ventilated San Francisco Federal Building prior to occupancy. Lawrence Berkeley National Laboratory performed limited measurements of workplane illuminance and window luminance using high dynamic range imaging and concluded that indoor shades would be needed to control direct sun and window glare on the southeast façade shaded by a 50 percent-transmittance metal scrim, and possibly on the northwest façade, which



was shaded by vertical translucent glass fins mounted perpendicularly to the façade. The GSA installed roller shades on the upper and lower apertures thereafter.

The delivery of sufficient daylighting to building interiors without causing glare is a central objective of “high performance” buildings that attempt to use daylight as a strategy to reduce electrical lighting energy consumption. However, there is currently no consensus for the appropriate discomfort glare model (Veitch et al. 1993), and there are limited data from buildings in use comparing predictions from discomfort glare models to subjective assessments made by occupants in those buildings. Because discomfort glare often leads occupants to lower interior shading devices (which may remain lowered for weeks or even months, significantly limiting daylight availability), it is important to develop and validate predictive models of discomfort glare to provide appropriate guidance during design. Such models are also of use for the development of control strategies for shading systems.

Lawrence Berkeley National Laboratory approached GSA to determine if a post-occupancy study could be conducted in the building. Kyle Konis, a Ph.D. candidate at the time and part of the LBNL team, took on the study as part of his research dissertation. Konis developed a novel field-based approach that pairs subjective measures of discomfort glare with simultaneous luminance measures using high dynamic range (HDR) imaging to develop a body of data describing the physical lighting conditions acceptable to occupants. The approach was demonstrated in a six-month longitudinal field study involving six multi-week monitoring phases and 44 occupants located in perimeter and core office spaces in the building. Over 23,100 subjective assessments paired with physical measures were analyzed to develop and validate models of discomfort glare and to examine the assumptions of existing daylighting performance indicators.

### *Outcomes*

Konis related the occupant-subjective assessments to physical measures and found that existing discomfort glare models underestimated the level of discomfort and were less accurate predictors of discomfort compared to basic statistics computed from HDR images (e.g., maximum window luminance). Variables obtained from simple statistics applied to predefined regions of HDR images were found to be more accurate predictors of discomfort glare than existing models such as the DGI (an evaluation of the DGP metric was not possible at the time of this investigation). For example, the maximum luminance of the upper windows was found to correctly predict between 76 percent and 82 percent of the subjective responses.

Konis also found that increased daylight levels at the task did not necessarily correlate with greater occupant satisfaction. The level of both satisfaction and dissatisfaction were found to increase with the magnitude of daylight illuminance at the workplane. This result conflicts with the common assumption that “maximizing” the physical level of daylight transmission will have a positive effect on occupant satisfaction with the amount of daylight in the workspace.

Time-lapse observation of interior roller shades showed that existing shade control models overestimated the frequency of shade operation and underestimated the level of façade occlusion due to interior shades, leading to overestimations of daylight availability and energy

savings for simulations of manually controlled shades. Even though the building had separate shades for the upper and lower window, which is atypical of most commercial buildings, the majority of study participants shaded over half of the high transmittance glazing in the lower vision zone and an even greater portion of glazing in the upper clerestory zone. Occupants rarely (or never) adjusted the shade position over the six-month monitored period. When operated, Konis found that the probability of shade-lowering events agreed with the probabilistic models developed by Inkarojrit (2005) from field data. When compared to threshold-based models (e.g., Lee et. al. 1995; Reinhart and Voss 2003), the probabilistic models developed from the federal building showed a high probability that shades would be lowered at stimulus intensities defined as acceptable by the threshold models (e.g., transmitted solar radiation < 50 watts per square meter [ $W/m^2$ ]). Because data for shade activation were limited (n = 14 participants, 245 observations) and the configuration and use of the shades across the façade was complex, Konis cautioned that the shade control conclusions were limited in scope.

These findings point to potential solutions for automated controls systems. For example, metrics and therefore controls for discomfort glare could be simpler than those based on the full DGI metric. Energy savings due to automated shading systems are also likely to be greater than that estimated with simulations using existing models for shade control. More details of the study can be found in the full dissertation (Konis 2011).

## **4.5 Conclusions and Recommendations**

### **4.5.1 Conclusions**

One of the most critical challenges of automatic control systems is convincing owners and specifiers that such systems work provides added value, and in the case of fenestration systems that have a direct impact on occupants, are acceptable in both their operation and their impact on the quality of the environment. With traditional heuristic controls, simple PID controls can only get us so far as we strive to achieve very low-energy performance goals. This project demonstrated that model predictive controls can satisfy complex and conflicting performance metrics more optimally, and with increased integration with other building systems, using a framework that can be widely deployed in the industry and tailored to individual building applications at relatively low cost. A field test in the LBNL Advanced Windows Testbed demonstrated controls that minimize lighting and HVAC energy use, resulting in 18 percent reduction in total energy use compared to control algorithms that block direct sun, which constitute the majority of products offered on the market today. The power of this solution is transformative and has been demonstrated successfully on complex problems in the aerospace and transportation industries (e.g., self-driving cars).

This work has also created a unique testbed environment that enabled partner manufacturers (Philips North America, MechoSystems, Nysan) to perform a rapid design-evaluate iterative test cycle on their proprietary prototype control systems under real sun and sky conditions in a hardware-in-the-loop testing environment. As integrated façade systems move beyond traditional heuristic, feedback controls and enter the realm of whole-building integrated controls, it will be important for industry to develop and test their control systems in concert with other building systems within the confines of a virtual and lab-based test environment. In

some “demonstration” projects, the manufacturer performed debugging and even product development at the building site for more than six months after the installation of the “proven” product, eroding the owner’s confidence in the technology as a whole. This testing environment proved useful in our collaborations with manufacturers and provided a useful precedent to LBNL’s new FLEXLAB facility.

The project team vetted the concept of model predictive controls (MPC) to experts in the field in order to understand the opportunities and barriers for widespread adoption. Model predictive controls are making their way into building controls, primarily for HVAC components in the United States, although there are front runners like Philips North America who are developing MPC for use with shading and lighting control systems. Lawrence Berkeley National Laboratory is developing an open-source Buildings library in Modelica to broaden use of MPC-based controllers for the whole industry. In the European Union, where MPC has gained significant traction for building and urban systems control, many of the Modelica models have been developed by manufacturers and are proprietary. Clearly there is a significant opportunity to achieve controls optimization of integrated buildings systems.

There were, however, two valid areas of concern voiced by owners/adopters: (1) the level of expertise needed to maintain the model and controls over the life of the building, and (2) the added value for the incremental increase in complexity and cost. Building owners and facility managers remain skeptical that automatic control for individual building components can work, let alone integrated control systems for an array of components with their own proprietary systems across the building or campus for increased optimization. The practical concern regarding the level of expertise to maintain the MPC-based systems is valid, but this concern is valid whether based on heuristic- or MPC-derived logic. Both system types require that the development team stay engaged throughout the life of the installation, to modify the system as the context around the building or its use changes. As for complexity, we can only point to what other industries have accomplished to solve critical challenges of the day (e.g., antilock braking systems, cruise control, air bags, self-driving cars) and the resultant solutions for maintaining them (auto-diagnostics in every repair shop) given the business-as-usual perspectives of the day (e.g., owners who maintained their 1960s VW Beetle in their garage). Buildings, particularly dynamic window and dimmable lighting systems, constitute a major controllable load on the utility grid. There is significant R&D being conducted to develop Smart Grid technologies as on-site power generation and electric vehicles become more prevalent in California. Smart building controls are a rapidly developing industry, and the transactive costs associated with potential solutions have not yet been worked out. The R&D performed in this project provides an initial framework to explore other synergistic opportunities that may yield benefits at the individual consumer level and urban/grid/societal level.

New switchable materials are being developed as an alternate to motorized façade systems. Since such development efforts require considerable investments to bring products to the market, design guidance and estimates of technical energy savings potential were provided to stakeholders to guide those investments. The near-infrared switchable electrochromic windows developed by the new California-based startup company, Heliotrope, provides an exciting alternative to the near-term absorptive electrochromic windows that are now entering the

market. Other manufacturers are developing passive thermochromic switchable devices that can lower costs significantly, but the benefits of this technology were found to be not as clear cut.

A key, but obvious lesson learned from each of the demonstration projects is that due diligence is key to a successful implementation of dynamic controls in real buildings. Due diligence is defined ideally as a single individual vested in understanding the technical details of the system, making sure the vendor fully commissions the systems prior to signing off on the contract, and continuing to maintain proper operation of the system over the life of the building. One success story is another's failure due to lack of follow-through on the part of the owner's representative. For emerging systems bordering on late-stage prototypes, the challenge is that control errors do occur, either due to software errors or because the control logic does not adequately address the performance criteria needed for user acceptance. In these cases, lessons learned in the pilot demonstrations served to inform the manufacturer of needs for improvement.

User satisfaction, acceptance, and comfort associated with automated shading systems are critical for widespread adoption of this technology. The New York Times post-occupancy evaluation concluded that significant energy savings were attained, and that the overall indoor environmental quality was found to be very satisfactory by the majority of the occupants and that it contributed to their ability to get their job done. There were mixed reviews with the automated shading, with visual discomfort being the single most-voiced complaint. This aspect of control is one that many manufacturers have been dedicating considerable resources to solve.

#### 4.5.2 Recommendations

Automatically controlled shading systems have been commercially available since the mid-1970s and have incited the imagination of architects for at least as long, given analogies of the building façade to the responsive skin of a living organism. This project demonstrated that façade intelligence can be raised significantly with transformative technologies such as model predictive controls, enabling consideration of complex performance criteria at the component, systems, building, campus and grid level within a practical, low-cost framework. It is recommended that further development and deployment of such systems be encouraged to improve whole-building systems integration and occupant comfort, particularly as related to discomfort glare.

Performance is dependent on the properties of the controllable device. In the United States, there have been few cases involving automated exterior shading—the UCSD project mentioned in this study being an exception. This type of system provides the greatest opportunity for active load management and should be promoted, as well as between-pane systems. Hardware improvements in motorization for louvered shading systems are recommended to increase system responsiveness without incurring occupant dissatisfaction. For example, systems actuated more frequently and with greater precision are more likely to satisfy performance objectives. However, frequency must be balanced against increased potential hardware failure and annoyance due to visual or noise distractions. This has been a long-standing issue, and there are admittedly cost trade-offs between encoded direct current (dc) or alternating current

(ac) motorized systems. Lawrence Berkeley National Laboratory developed a quiet, precise encoded dc motorized system in the mid-1990s for between-pane venetian blinds. It would be useful if industry were able to offer cost-competitive solutions, given the rising interest in this technology.

Case study data are critical for broad market deployment. After the well-publicized and documented implementation of automated roller shades in The New York Times Building, the technology has been used in other buildings with varying degrees of success. Success was tied to the controls: poorly designed and/or executed controls have resulted in rather vocal condemnation of the industry as a whole. It will be important to distinguish market failures of the technological solution from those where the client failed to follow through on proper execution (e.g., omission of key control features that would make the project a success, in order to cut costs). At the same time, it will be important for manufacturers to develop more robust, reliable turnkey systems.

#### 4.5.3 Commercialization Potential

Optimization-based dynamic façade control could find its way into practice in a variety of ways, particularly by using the approach developed in this project and embodied in the cloud-based application. A façade manufacturer or assembler might employ a single expert (or hire a consultant) to tailor such an application to their product line, and then non-experts could use it to produce customized controllers for particular assembly configurations and installation contexts. It could be used by shading system companies or by architects or engineers working on individual buildings.

The proof-of-concept demonstration in the Advanced Windows Testbed have shown that using this approach, customized optimization-based control logics could be produced with computational expenses on the order of \$5–\$20 and implemented very simply on cheap control hardware. Future projects should focus on the process of integrating this approach into business and design practices within the building industry.

#### 4.5.4 Benefits to California

Dynamic fenestration systems can provide significant energy and peak-demand reductions over conventional manually operated systems through active management of window heat gains and daylighting. The systems can be coupled with low-energy cooling systems and thermal mass, enabling the building to coast through peak periods when the environmental cost of energy in California is particularly high. Dynamic fenestration systems can contribute to reaching the long-term strategic goals of zero net energy use in California through integration and optimization with other building systems.

California is well positioned to be a leader in smart building control technology. The optimization-based control approaches for dynamic façades that were developed and demonstrated in this research can not only produce smarter dynamic façade control, but can also be extended to provide a coherent framework whereby other parts of the building can interact in a way that reduces energy use. These techniques can help to make and keep California companies on the leading edge of the competitive buildings industry.

# CHAPTER 5:

## Program-wide Market Connections

### 5.1 Approach and Goals

This project's overall goal was to develop and accelerate adoption of innovative emerging fenestration technologies for use in new and retrofit construction, enabling California to reach its ambitious energy-efficiency and greenhouse gas emission-reduction goals in the near term. Therefore, it was of critical importance that a program-wide market connections strategy be developed and implemented in order to fulfill this overall project goal.

This project had the following specific objectives:

- Maintain close market connections with industry in order to guide development of practical, market-ready, energy-efficient façade technologies, to facilitate the design and specification of these technologies, to inform energy codes and other processes, and to identify future market-driven public interest façade research opportunities.
- Make available to key decision-makers the knowledge gained and experimental results and lessons learned from the energy-efficient façade products developed in this project.
- Inform and develop key strategic partners to support the expansion of market opportunities, such as sponsoring pilot programs, promoting projects to their members, identifying additional market connection opportunities, or some combination of these actions.

The approach for achieving program-wide market connections consisted of the following:

- Developing and leveraging direct partnerships with industry to understand the market context, critical barriers, and opportunities for improving the performance of an emerging technology and accelerating its market adoption. Lawrence Berkeley National Laboratory used either non-disclosure agreements or cooperative research and development agreements to define the specific details of collaboration with industry partners.
- Disseminating results of knowledge gained in this project through peer-reviewed publications; conference presentations; individual meetings with stakeholders; tours of laboratory and testbed facilities; participation in codes and standards organizations; public announcements through popular press; release of open source, free, publicly available software; and informational websites.
- Supporting expansion of market opportunities through building demonstrations in partnership with California utilities, the Commercial Buildings Initiative at the U.S. Department of Energy, the Federal Energy Management Program, and the General Services Administration Green Proving Ground program.

## 5.2 Outcomes

The research in this project focused on three general classes of technologies: daylighting, shading, and dynamic systems. For each class, the methods used for market connection were tailored to each project's objective, depending on the level of maturity of the technology and the critical barriers and opportunities for market deployment.

All of the technologies studied in this project required that new measurements and modeling tools be developed to characterize the properties of the systems and enable stakeholders to evaluate the energy-efficiency and comfort performance impacts of the technology in buildings. Without accessible modeling tools, development of product rating systems or industry actions to include products in energy-efficiency codes and standards cannot move forward. Project activities focused on developing, debugging, and to the extent possible validating core engine modules within WINDOW, Radiance, and EnergyPlus. Activities also focused on developing models and populating the window products database with the highest-priority fenestration systems, as defined by the Attachments Subcommittee of the National Fenestration Rating Council (NFRC). Through both tools R&D and active participation on standards committees, LBNL played a central role in enabling industry to promote optically complex fenestration systems, otherwise known as *attachments*, worldwide. These core activities also set the stage for inclusion of optically complex fenestration technologies in the 2016 revision of the Title 24 building energy-efficiency standards.

To support the design and engineering community, LBNL also worked with third-party software developers building user-friendly interfaces to Radiance and EnergyPlus to incorporate new model developments into their software. Within this project, team members also built the COMFEN software tool, enabling the architectural/ engineering (A/E) community to conduct quick what-if comparisons of energy use, peak electric demand, cost, and comfort at the schematic design level (Selkowitz et al. 2011). This work also supported the development of a web-based tool (Haglund 2013) in partnership with the University of Minnesota (UMN). Lawrence Berkeley National Laboratory and UMN had originally developed a book and website together on commercial building fenestration with the support of DOE (Carmody et al. 2004). The tool is an extension of the book, providing end users with a similar but more limited ability to compare the performance of fenestration designs and products. Many of the window manufacturers have directly supported manufacturer-specific versions of this website for use in client discussions. The underlying database for the tool was extended using many of the new modeling capabilities developed in this project.

Demonstration projects were the primary method used for generating market pull of these emerging technologies. For all of the new technologies, it was critical to understand owner, facility manager, and occupant response to them and to uncover any unanticipated technical barriers to widespread adoption. Conducting limited demonstrations of façade technology is a relatively straightforward approach to evaluate implementation, technical, and market barriers at a first-pass, anecdotal level. Conducting demonstrations that yield accurate HVAC data and occupant response data that are statistically significant across a representative sample of the population is quite involved, given the time and expense needed to conduct such a study.

Because demonstration activities were not directly funded by this project, over the course of this project, partner manufacturers and LBNL contacted California utilities in order to identify opportunities for technology demonstrations. For the most part, we were informed that while of interest, window technologies were beyond the scope of their limited demonstration programs: most demonstrations involved a simple in-situ test conducted by utility staff within time frames of no more than a month. Instead, partnerships were developed through DOE-supported demonstration programs. These were described in the chapters above.

There were other valuable opportunities for engaging with the market actors that helped to inform project team members of potential market opportunities and barriers to adoption. Lawrence Berkeley National Laboratory made regular presentations of recent work at major industry conferences (e.g., GreenBuild, LightFair, ASHRAE, Illuminating Engineering Society of North America (IESNA), the international society for optics and photonics (SPIE), Glass Processing Days), and provided tours of LBNL laboratories and field test facilities at least twice a week to visitors from all over the world. Some of the interactions resulted in collaborations where LBNL provided limited technical support to the design teams and/or building owner across design development and bid phases. To support informed decisionmaking, LBNL relayed third-party data and experience related to the technologies, provided direct technical support to the design team for modeling and specifications, and in some instances, invited the owner and design team to have a firsthand view of the technology in operation at the Advanced Windows Testbed.

Peer-reviewed journal articles were used primarily to convey the results of simulation and experimental studies of prototype technologies and to document development of new modeling capabilities in Radiance and EnergyPlus. Results of demonstration projects were conveyed according to the requirements of each individual program. All products of the research resulting from this project are available on the project and PIER websites: <http://facades.lbl.gov>.

## **5.3 Conclusions and Recommendations**

### **5.3.1 Conclusions**

For the general classes of technologies investigated for this project, the project's market pull activities were successful in addressing critical industry needs. Given the U.S. economic context during the time of this project, manufacturers were primarily focused on the day-to-day business of selling product in the marketplace, and simulation tools were key in helping them do that. Panelite is one such example: the modeling tools and product data enabled Panelite to compete more effectively for jobs by working with the engineering team to generate comparative performance data in client discussions. View Dynamic Glass was previously unable to model control of their multi-state switchable electrochromic windows. Additions of solar-optical data and new features in WINDOW, EnergyPlus, and COMFEN enabled View to model its product for client discussions, as well as to develop new control systems in a design-evaluate test cycle. Simulations and monitored field data enabled 3M to point to independent sources of data when they launched their product in 2011. Post-occupancy data demonstrated the value of MechoSystems automated shading and Lutron dimmable lighting in



a 111 km<sup>2</sup> (1.2 million ft<sup>2</sup>) commercial office building, providing other owners with solid information on which to base purchasing decisions.

Equally important were the technology development activities conducted within the scope of this project that quantified the value added by the three classes of technologies in terms of energy savings, peak electric demand reductions, comfort, and indoor environmental quality. For all of the technologies, these impacts have not been evaluated systematically using comparable, standardized methods. The analysis approaches used in this study go far beyond what has been accomplished to date in prior projects, not only due to improvements in the solar-optical and thermal models, but also in the methods used to quantify discomfort glare and occupant behavior as related to their control of glare. As California continues to work towards its goal of zero net energy use in buildings, improvements in modeling accuracy and verification of performance in the field given occupant behavior will become increasingly important.

This project set the stage for continued growth in the uptake of these technologies in the California and U.S. markets and beyond. It developed advanced virtual prototyping tools with which industry can remain competitive by accelerating the design-test-evaluation cycle using supercomputing resources. Results also point to how the integration of component technologies can lead to zero net energy solutions—for example, integration of angular selective shading coupled with daylight-redirecting systems, daylighting controls, and low-energy cooling strategies. With supercomputing resources now at the disposal of the manufacturing and architectural/engineering community, we anticipate significant advances in technological innovation in the years to come.

### 5.3.2 Recommendations

It will be important for stakeholders to understand that there are what appear to be immutable market factors that fundamentally work against an accelerated uptake of energy-efficient fenestration technologies: a market defined by a simple payback of less than two to five years. The focused investment by DOE in supporting market deployment of low-cost interior shading attachments for the residential sector is a testament to the pragmatic, near-term decisionmaking criteria used to rank the order of technology R&D investments. Fenestration technologies in the commercial sector play a major role in defining both the aesthetic appearance of the façade and quality of the indoor environment. All owners are aware of this fact when it comes to market valuation of real estate. It is, however, very difficult to assign a dollar value for this “je ne sais quoi” quality of a building. For the more costly fenestration technologies with greater energy-savings potential, such as exterior or between-pane shading, daylighting systems, or dynamic window, it is recommended that stakeholders look to supporting demonstrations at the leading innovators edge of the adoption curve, rather than the early majority. Such demonstrations can create enormous market pull on impactful, innovative technologies if they are used in the right context (e.g., expanded metal mesh scrims by Frank Gehry and popularized by Morphosis; automated shades in The New York Times headquarters building) and can lead the market toward zero net energy solutions, which is the overall goal of the DOE and PIER programs.

The upsurge in funding energy-efficiency research, the result of stimulus funding during the global recession, led to significant accelerated progress in fenestration R&D. As federal funding levels drop, it will be important for industry to coalesce and define strategic initiatives with a less myopic near-term outlook. Clean tech offers the United States an opportunity to lead the world in innovation. Public investments toward solutions that enable the nation to realize aggressive greenhouse gas emission goals are anticipated to maintain U.S. competitiveness for decades to come.

Other countries with more advanced energy-efficiency codes have decoupled measures related to HVAC performance from fenestration performance, leading to a more equitable basis for promoting window technologies into the market. Fenestration technologies are installed for the life of the building, often 50–100 years, while HVAC and lighting systems are replaced every 10–15 years or sooner. In the United States, building energy-efficiency codes are developed based on least-cost measures identified by building energy simulations of prototypical buildings. Fenestration measures do quite poorly in this context because air-based HVAC systems are over-designed, and therefore unresponsive to even significant reductions in perimeter zone loads brought about by the fenestration system: e.g., a 50 percent load reduction produced by an advanced window technology results in a minimal reduction in HVAC energy use when modeled using the ASHRAE 90.1-2010 large office commercial building prototype. In Japan, where the Ministry of Transportation and Construction has defined ambitious goals for zero net energy use in buildings, mandatory measures in the 2011 energy-efficiency codes define a maximum perimeter zone annual load (e.g., 25,000 Btu per square foot per year for a perimeter zone depth of 5 m from the window wall [Shimuzu 2010]). This separates the dependency of envelope-related energy-efficiency codes from the particulars of HVAC performance and drives industry toward more-efficient envelope solutions. With this context, market push activities for energy-efficiency measures are aligned with ambitious goals for reduction of energy and carbon emissions.

### 5.3.3 Commercialization Potential

The commercialization potential for each class of technologies is discussed in the previous chapters.

### 5.3.4 Benefits to California

Several specific California partners have benefited directly from collaboration with LBNL on this project. View (electrochromic windows) in Milpitas, California, and Applied Materials in Silicon Valley benefited from frequent collaboration with LBNL as they scaled up on high-volume manufacturing processes and developed their control system for public release of their product in early 2013. The Ventures and Business Development business unit of the Dow Chemical Company in Burlingame, California, held frequent exchanges with LBNL as they considered strategic areas for new product development, some of which were slated for R&D development in California. Panelite in Los Angeles, mentioned several times above, benefited both from product characterization and LBNL-assisted improvements to their technology. The University of California, San Diego, received technical assistance from LBNL throughout the design and construction of a new very-low-energy biomedical building. In all of these cases,

manufacturers and building owners were steered toward investing in the development or deployment of advanced energy-efficiency products that can help California reach its goal of lower energy use and carbon emissions.

## GLOSSARY

<b>Term</b>	<b>Definition</b>
°C	degrees Celcius
°F	degrees Fahrenheit
A/E	architectural/engineering
ac	alternating current
ARPA-E	Advanced Research Projects Agency
ASHRAE	American Society of Heating, Refrigerating and Air-Conditioning Engineers
ASTM	American Society for Testing and Materials
BCVTB	Building Controls Virtual Test Bed
BSDF	bidirectional scattering distribution function. Angularly resolved optical reflectance and transmission characteristics.
CA	California
CAD	computer aided design
CBECS	U.S. Commercial Building Energy Consumption Survey
cd/m <sup>2</sup>	candela per square meter
CEUS	California Commercial End-Use Survey
CFS	complex fenestration system. Fenestration with non-specular optical transmission, including diffusion and redirection of light (e.g., venetian blinds, woven shades, ceramic frit, micro-prismatic film). Excludes conventional glass.
CGDB	complex glazing database
CO <sub>2</sub>	carbon dioxide
COMFEN	Commercial Fenestration simulation tool
COP	coefficient of performance
CPU	central processing unit
CPUC	California Public Utilities Commission
dc	direct current

DC	daylight coefficient method
DGI	daylight glare index
DGP	daylight glare probability. A daylight discomfort glare metric developed at Fraunhofer ISE based on human subject tests.
DGPs	daylight glare probability simplified A version of the DGP metric calculate using only vertical illuminance at the eye.
DOE	Department of Energy (U.S.)
DP	dynamic prism coating
EC	electrochromic
EC2	Elastic Compute Cloud
EERE	U.S. Department of Energy's (DOE) Office of Energy Efficiency and Renewable Energy
EMD	earth mover's distance algorithm allows for interpolation by moving peaks from one location to another.
EMS	energy management system
Energy Commission	California Energy Commission
EU	European Union
EUI	energy use intensity
fc	footcandle
FDTD	finite-difference time-domain
FEM	finite element method
FLEXLAB	Facility for Low Energy Experiments in Buildings
ft	feet
ft <sup>2</sup>	square foot
genBSDF	a Radiance sub-program
GenOpt	Generic Optimizer. An LBNL-developed tool for determining input parameters that produce an optimal result.
GHG	greenhouse gas

GPU	graphics processing unit
GSA	General Services Administration
GUI	graphical user interface
HDR	high dynamic range
HMG	Heschong Mahone Group
http	hypertext transfer protocol
HVAC	heating, ventilation and air conditioning
I/O	input/output
IEQ	indoor environmental quality
IESNA	Illuminating Engineering Society of North America
IGDB	International Glazing Database
IGDB	International Glazing Database
IGU	insulated glazing unit. A glazing unit with two or more glass panes and an airtight gap in between.
IGU	Insulating glass unit
ISO	International Organization for Standardization
kWh	kilowatt-hour
kWh/ft <sup>2</sup> -yr	kilowatt-hours per square foot per year
LBNL	Lawrence Berkeley National Laboratory
LED	light-emitting diode
low-e	low-emittance
LPD	lighting power density
m	meters
MBE	mean bias error
MPC	model predictive controls
NFRC	National Fenestration Rating Council
NIR	near-infrared
NREL	National Renewable Energy Laboratory

PCM	phase change material
PID	proportional-integral-derivative
PIER	Public Interest Energy Research
PMMA	polymethyl methacrylate
PV	photovoltaic
R&D	Research and Development
RMSE	root mean square error
RSHGC	Relative Solar Heat Gain Coefficient
Rsol	solar reflectance
Rvis	visible reflectance
s	seconds
SHGC	solar heat gain coefficient
SPIE	international society for optics and photonics
TBtu	Tera Btu ( $10^{12} \times$ Btu)
TC	thermochromic
Tsol	solar transmittance
Tvis	visible transmittance
UCSD	University of California at San Diego
U-factor	overall heat transfer coefficient that describes how well a building element conducts heat or the rate of transfer of heat (in watts)
UFAD	under floor air distribution
UMN	University of Minnesota
VAV	variable air volume
VB	venetian blind
W	watt
WWR	wall-to-window ratio
XML	Extensible Markup Language
ZEB	Zero energy building

ZGF	Zimmer Gunsul Frasca
ZNE	zero net energy



## REFERENCES

- Andersen, M., M. Rubin, R. Powles, and J.-L. Scartezzini. 2005. "Bi-directional transmission properties of Venetian blinds: Experimental assessment compared to ray-tracing calculations." *Solar Energy* 78 (2005):187–198.
- Andersen, M. and J. de Boer. 2006. "Goniophotometry and assessment of bi-directional photometric properties of complex fenestration systems." *Energy and Buildings* 38: 836–848.
- Andersen, M., E. Stokes, N. Gayeski, and C. Brown. 2010. "Using digital imaging to assess spectral solar-optical properties of complex fenestration materials: A new approach in video-goniophotometry." *Solar Energy* 84(4): 549–562.
- ARRA 2009. Accessed January 5, 2014:  
[http://en.wikipedia.org/wiki/American\\_Recovery\\_and\\_Reinvestment\\_Act\\_of\\_2009](http://en.wikipedia.org/wiki/American_Recovery_and_Reinvestment_Act_of_2009)
- Beltrán, L. O., E. S. Lee, and S. E. Selkowitz. 1997. "Advanced optical daylighting systems: Light shelves and light pipes." *Journal of the Illuminating Engineering Society* 26(2):91–106.
- Bourgeois, D., C. F. Reinhart, and G. Ward. 2008. "Standard daylight coefficient model for dynamic daylighting simulations." *Building Research & Information* 36: 68–82.
- Brook, M., C. Collopy, D. Eden, T. Ferris, C. Graillat, H. Lam, S. Lerman, R. Menten, B. Pennington, J. Regnier, K. Roberts, and J. Wu. 2012. *Comprehensive Energy Efficiency Program for Existing Buildings Scoping Report*. California Energy Commission, Efficiency and Renewable Energy Division. Publication number CEC-400-2012-015.
- California Energy Commission (CEC). 2012. *Draft Electricity Program Investment Charge Proposed 2012-14 Triennial Investment Plan*. CEC-500-2012-082-SF.
- California Energy Commission. 2007. *Integrated Energy Policy Report*. California Energy Commission. CEC-100-2007-008-CMF. Accessed January 5, 2014:  
[http://www.energy.ca.gov/2007\\_energypolicy/documents/index.html](http://www.energy.ca.gov/2007_energypolicy/documents/index.html).
- California Public Utilities Commission. 2008. *California Long-Term Energy Efficiency Strategic Plan*. California Public Utilities Commission. September 2008. Accessed January 5, 2014:  
[www.CaliforniaEnergyEfficiency.com](http://www.CaliforniaEnergyEfficiency.com).
- Carmody, J., S. Selkowitz, E.S. Lee, D. Arasteh, and T. Wilmert. 2004. *Window Systems for High Performance Commercial Buildings*. New York: W.W. Norton and Company, Inc.
- Clear, R. D. 2010. *Technical Memo: Post-occupancy evaluation of The New York Times Headquarters Building: An examination of causes for occupant satisfaction and dissatisfaction with the energy-efficiency measures*. Lawrence Berkeley National Laboratory, Berkeley, California.
- Coffey, B., and E. S. Lee. 2011a. *Model-based controls for integrated shading and UFAD control: Report on initial studies*. October 30, 2011.

- Coffey, B. 2012a. Integrated control of operable fenestration systems and thermally massive HVAC systems: Methods and simulation studies of energy savings potential. DOE Technical Report. September 30, 2012.
- Coffey, B. 2011b. Using Building Simulation and Optimization to Calculate Lookup Tables for Control. PhD Thesis, University of California Berkeley, 2011.
- Coffey, B., A. McNeil, T. Nouidui, and E. S. Lee. 2013a. Automated Production of Optimization-Based Control Logics for Dynamic Façade Systems, with Experimental Application to Two-Zone External Venetian Blinds. PIER Technical Report. September 30, 2013.
- Curcija, D. C., and C. J. Jonsson. 2011. Personal communication on spectral measurements of thermochromic windows. Lawrence Berkeley National Laboratory. October 13, 2011.
- DeForest, N., A. Shehabi, D. J. Milliron, G. Garcia, S. Selkowitz, E. S. Lee, E. Masanet, and J. Greenblatt. 2013. "Developing regional performance targets for transparent electrochromic window glazings." *Building and Environment* 61 (2013): 160–168.
- DOE. 2010. U.S. DOE Office of Energy Efficiency and Renewable Energy, 2010 Buildings Energy Data Book. U.S. Department of Energy, Office of Energy Efficiency and Renewable Energy. Table 3.1.5. <http://btscoredatabook.eren.doe.gov/>.
- DOE. 2012. U.S. DOE Office of Energy Efficiency and Renewable Energy. Solid-State Lighting Research and Development: Multi-Year Program Plan. April 2012. [http://apps1.eere.energy.gov/buildings/publications/pdfs/ssl/ssl\\_mypp2012\\_web.pdf](http://apps1.eere.energy.gov/buildings/publications/pdfs/ssl/ssl_mypp2012_web.pdf).
- EERE Network News. 2010. Accessed January 5, 2014: [http://apps1.eere.energy.gov/news/news\\_detail.cfm/news\\_id=16103](http://apps1.eere.energy.gov/news/news_detail.cfm/news_id=16103).
- Fernandes, L. L., and E. S. Lee. Designing improved angular-selective shading systems. DOE Technical Report. September 30, 2013.
- Fernandes, L. L., E. S. Lee, D. L. DiBartolomeo, and A. McNeil. 2013. Monitored lighting energy savings from dimmable lighting controls in The New York Times Headquarters Building. *Energy and Buildings* 68 (2013): 498-514. LBNL-6171E.
- Fernandes, L. L., E. S. Lee, A. McNeil, J. C. Jonsson, T. Nouidui, X. Pang, and S. Hoffman. Angular selective window systems: Assessment of technical potential for energy saving. DOE Technical Report. September 30, 2012, revised January 14, 2014.
- Fleischhaker, F., A. C. Arsenault, Z. Wang, V. Kitaev, F. C. Peiris, G. von Freymann, I. Manners, R. Zentel, and G. A. Ozin. 2005. "Redox-Tunable Defects in Colloidal Photonic Crystals." *Adv Mater* 17 (2005): 2455–2458.
- Erhorn, H. Fraunhofer-Institut für Bauphysik. International Energy Agency Task 31 Daylight in Buildings in the 21st Century, Subtask C Meeting. Turino, Italy, 2004.
- ESTCP. 2013. U.S. Department of Defense Environmental Security Technology Certification Program (ESTCP). <http://www.serdp.org/Program-Areas/Energy-and->

Water/Energy/Conservation-and-Efficiency/EW-201014/EW-201014/(language)/eng-US#factsheet-6986-objective\_ Accessed April 9, 2013.

Garcia, G., R. Buonsanti, A. Llordes, E. L. Runnerstrom, A. Bergerud, and D. J. Milliron. "Near-Infrared Spectrally Selective Plasmonic Electrochromic Thin Films." *Advanced Optical Materials* 1(3):215–220 (2013).

Granqvist, C. G., S. Green, G. A. Niklasson, N. R. Mlyuka, S. von Kræmer, and P. Georén. "Advances in chromogenic materials and devices." *Thin Solid Films* 518 (2010) 3046–3053.

Haglund, K. 2013. Windows for high-performance commercial buildings.  
<http://www.commercialwindows.org/>

Hoffmann, S., E. S. Lee, and C. Clavero. 2013. Examination of the technical potential of near-infrared switching thermochromic windows for commercial building applications. *Solar Energy Materials and Solar Cells* 123 (2014) 65-80.

Hoffmann, S. and E.S. Lee. 2014. "Potential energy savings with exterior shades in large office buildings and the impact of discomfort glare." Submitted to Fourth Building Enclosure Science & Technology Conference (BEST4), Kansas City, Missouri, April 13-15, 2015.

Hong, T. 2011. "Thermochromic Windows" in *EnergyPlus Engineering Reference: The Reference to EnergyPlus Calculations*, October 1, 2013.

Inkarojrit, V. 2005. *Balancing Comfort: Occupants' Control of Window Blinds in Private Offices*. PhD Thesis, University of California Berkeley, 2005.

Itron. 2006. *California Commercial End-Use Survey*. Consultant Report to the California Energy Commission. CEC-400-2006-005. March.

Jonsson, J. C., E. S. Lee, and M. D. Rubin. 2008. "Light-scattering properties of a woven shade-screen material used for daylighting and solar heat-gain control." *Proc. SPIE* 7065, 706525.

Jonsson, J. C., M. Rubin, A. M. Nilsson, A. Jonsson, and A. Roos. 2009. "Optical characterization of fritted glass for architectural applications." *Optical Materials* 31(2009): 949–958.

Jonsson, J. C. 2013. Theory documentation for software to control the pgII phiro2 automated sample mount and analyzing data obtained. LBNL Technical report. September 2013.

Klems, J. H. 1994a. "A new method for predicting the solar heat gain of complex fenestration systems: I. Overview and derivation of the matrix layer calculation." *ASHRAE Transactions* 100 (1): 1065–1072.

Klems, J. H. 1994b. "A new method for predicting the solar heat gain of complex fenestration systems: II. Detailed description of the matrix layer calculation." *ASHRAE Transactions* 100 (1): 1073–1086.

- Klems, J. H., J.L Warner, and G. O. Kelley GO. 1997. "A comparison between calculated and measured SHGC for complex glazing systems." *ASHRAE Transactions* (102) 1: 931–939.
- Konis, K. S. 2011. *Effective Daylighting: Evaluating Daylighting Performance in the San Francisco Federal Building from the Perspective of Building Occupants*. PhD Thesis, University of California Berkeley, 2011. <http://escholarship.org/uc/item/7qg1945w#page-1>.
- Konis, K. and E. S. Lee. Measured daylighting potential of a static optical louver system under real sun and sky conditions. DOE Technical Memo. September 2011.
- Lee, E. S., S. E. Selkowitz, D. L. DiBartolomeo, J. H. Klems, R. D. Clear, K. Konis, R. Hitchcock, M. Yazdanian, R. Mitchell, and M. Konstantoglou. 2009. *High Performance Building Façade Solutions*. California Energy Commission, PIER.
- Lee, E. S. and S. E. Selkowitz. 1995. "The design and evaluation of integrated envelope and lighting control strategies for commercial buildings." *ASHRAE Transactions* 101(1): 326–342.
- Lee, E. S., S. Selkowitz, V. Bazjanac, V. Inkarojrit, and C. Kohler. 2002. High-performance commercial building façades. <http://gaia.lbl.gov/btech/papers/50502.pdf>.
- Lee, E. S., S. Selkowitz, G. Hughes, R. Clear, G. Ward, J. Mardaljevic, J. Lai, M. Inanici, and V. Inkarojrit. 2005. *Daylighting the New York Times Headquarters Building: Final Report*. Lawrence Berkeley National Laboratory. Berkeley, California. <http://gaia.lbl.gov/btech/papers/57602.pdf>.
- Lee, E. S., L. L. Fernandes, B. Coffey, et al. 2012. A post-occupancy monitored evaluation of the dimmable lighting, automated shading, and underfloor air distribution system in The New York Times Building. LBNL-6023E.
- Lee, E. S., E. S. Claybaugh, and M. LaFrance. 2012. "End User Impacts of Automated Electrochromic Windows in a Pilot Retrofit Application." *Energy and Buildings* 47 (2012): 267–284. doi 10.1016/j.enbuild.2011.12.003. LBNL-6027E.
- Lee, E. S., L. L. Fernandes, H. C. Goudey, et al. 2012. A Pilot Demonstration of Electrochromic and Thermochromic Windows in the Denver Federal Center, Building 41, Denver, Colorado. GSA/ GPG report deliverable, September 30, 2012.
- Lee, E.S., X. Pang, S. Hoffmann, H. Goudey, and A. Thanachareonkit. 2013. "An empirical study of a full-scale polymer thermochromic window and its implications on material science development objectives." *Solar Energy Materials and Solar Cells* 116 (2013): 14–26. <http://dx.doi.org/10.1016/j.solmat.2013.03.043i>.
- Li, S.-Y., G. A. Niklasson, and C. G. Granqvist. 2011. "Thermochromic fenestration with VO<sub>2</sub>-based materials: Three challenges and how they can be met." *Thin Solid Films* (2011). doi:10.1016/j.tsf.2011.10.053.

- McConahey, E. "Mixed Mode Ventilation: Finding the Right Mix." *ASHRAE Journal* 50 (9): 36–46. September 2008.
- McDowell, J. J., N. S. Zacharia, D. Puzzo, I. Manners, and G. A. Ozin. 2010. "Electroactuation of alkoxy silane-functionalized polyferrocenylsilane microfibers." *J American Chemical Society* (2010), doi:10.1021/ja9089236.
- McNeil, A. and E. S. Lee. 2010. Annual daylighting performance of a passive optical light shelf in sidelit perimeter zones of commercial buildings. [http://eetd.lbl.gov/sites/all/files/passive\\_optical\\_light\\_shelf.pdf](http://eetd.lbl.gov/sites/all/files/passive_optical_light_shelf.pdf).
- McNeil, A. 2011. On the sensitivity of daylight simulations to the resolution of the hemispherical basis used to define bidirectional scattering distribution functions. DOE Technical Memo. September 30, 2011.
- McNeil, A. and E. S. Lee. 2012. "A validation of the Radiance three-phase simulation method for modeling annual daylight performance of optically complex fenestration systems." *Journal of Building Performance Simulation* 6(1): 24–37.
- McNeil, A. 2013a. BSDFViewer: A utility for interactive exploration of BSDF datasets, [www.radiance-online.org/download-install/bsdf-viewer](http://www.radiance-online.org/download-install/bsdf-viewer).
- McNeil, A. 2013b. The five-phase method for simulating complex fenestration with Radiance. Radiance tutorial. August 26, 2013. <http://www.radiance-online.org/learning/tutorials/Tutorial-ThreePhaseMethod.pdf>.
- McNeil, A., C. J. Jonsson, D. Appelfeld, G. Ward, and E. S. Lee. 2013c. "A validation of a ray-tracing tool used to generate bi-directional scattering distribution functions for complex fenestration systems." *Solar Energy* 98 (2013): 404–414. DOE: 10.1016/j.solener.2013.09.032.
- McNeil, A., E.S. Lee, J.C. Jonsson. 2013d. Daylight performance of a microstructured prismatic window film in deep open plan offices, DOE Technical Report, September 30, 2013.
- Mitchell, R., C. Kohler, J. H. Klems, M. D. Rubin, D. K. Arasteh, C. Huizenga, T. Yu, and D. C. Curcija. 2008. WINDOW 6.2/Therm 6.2 Research Version User Manual. Lawrence Berkeley National Laboratory.
- Milliron, D. "Behind the Scenes: Smart Windows." December 12, 2012. <http://newscenter.lbl.gov/videos/2012/12/12/behind-the-scenes-smart-windows/>
- Nouidui, T., A. McNeil, C. Kohler, B. Coffey, and E. S. Lee. Modeling solar heat gains of complex fenestration systems using bidirectional scattering distribution functions, Radiance and Energy Plus. DOE Technical Report. September 30, 2011.
- Nouidui, T. S., M. Wetter, and W. Zuo. 2012. Validation of the window model of the Modelica Buildings library. Proceedings of SimBuild 2012. Madison, Wisconsin. August 2012.

- Nouidui, T. S., A. McNeil, and E. S. Lee. 2012. Development of a simulation-based controls framework for implementation of controls algorithms for complex fenestration systems. DOE Technical Report. September 30, 2012.
- Nicodemus, F. E. 1965. "Directional Reflectance and Emissivity of an Opaque Surface." *Appl Opt* 4: 767–773.
- Nilsson, A. M., and J. C. Jonsson. 2010. "Light-scattering properties of a Venetian blind slat used for daylighting applications." *Solar Energy* (84): 2103–2111.
- Optics 5, Lawrence Berkeley National Laboratory.  
<http://windows.lbl.gov/software/Optics/optics.html>.
- Reinhart, C. F., and K. Voss. 2003. "Monitoring manual control of electric lighting and blinds." *Lighting Research and Technology* 35(3):243–258.
- Rogers, Z. L., M. J. Holtz, C. M. Clevenger, and N. E. Digert. 2004. Mini-optical light shelf daylighting system. U.S. Patent 6,714,352 B2. March 30, 2004.
- Ruck, N., O. Aschehoug, S. Aydinli, J. Christoffersen, G. Courret, I. Edmonds, R. Jakobiak, M. Kischkoweit-Lopin, M. Klinger, E. S. Lee, L. Michel, J. L. Scartezzini, and S. Selkowitz. 2000. *Daylight in buildings: A source book on daylighting systems and components*.  
<http://gaia.lbl.gov/iea21/>.
- Saelens, D. 2002. *Energy Performance Assessment of Multiple-skin facades*. PhD dissertation. Leuven: K. U. Leuven, Laboratory for Building Physics.
- Selkowitz, Stephen E., Robin Mitchell, Maurya McClintock, Daniel McQuillen, Andrew McNeil, and Mehry Yazdanian. "COMFEN 3.0: Evolution of an Early Design Tool for Commercial Facades and Fenestration Systems." *Proceedings of the Building Enclosure Sustainability Symposium, Pomona, CA, April 29-30, 2011*
- Selkowitz, S. E., M. Rubin, E. S. Lee, R. Sullivan, E. Finlayson, and D. Hopkins. 1994. *A Review of Electrochromic Window Performance Factors*. SPIE International Symposium on Optical Materials Technology for Energy Efficiency and Solar Energy Conversion XIII. April 18–22, 1994. Friedrichsbau, Freiberg, Germany. LBNL-35486.
- Schregle, R., and J. Weinold. 2004. "Physical Validation of Global Illumination Methods: Measurement and Error Analysis." *Computer Graphics Forum* 23 (4): 761–81.
- Shehabi, A., N. DeForest, A. McNeil, E. Masanet, E. S. Lee, and D. Milliron. 2013. "U.S. energy savings potential from dynamic daylighting control glazings." *Energy and Buildings* 66 (2013): 415–423.
- Shimuzu, M. 2010. Personal communication between Michiya Suzuki, Energy Conservation Technology Group and Eleanor Lee, LBNL. October 18, 2010 at the Shimuzu Corporation, Tokyo.

- Thanachareonkit, A., E.S. Lee, A. McNeil, Empirical assessment of a prismatic daylight-redirecting window film in a full-scale office testbed, *Leukos: The Journal of the Illuminating Engineering Society of North America* 10 (1): 19-45 (2014).
- U.S. DOE 2010. 2010 Buildings Energy Data Book. U.S. Department of Energy, Building Technologies Program, Energy Efficiency and Renewable Energy. Tables 1.1.1 and 1.2.3.
- Veitch, J. A., D. W. Hine, and R. Gifford. 1993. "End users' knowledge, preferences, and beliefs for lighting." *Journal of Interior Design* 19(2): 15–26.
- Ward, G., R. Mistrick, E. S. Lee, A. McNeil, and J. Jonsson. 2010. "Simulating the daylight performance of complex fenestration systems using bidirectional scattering distribution functions within Radiance." *Leukos, Journal of the Illuminating Engineering Society of North America* 7(4).
- Ward, G., M. Kurt, and N. Bonneel. 2012. A Practical Framework for Sharing and Rendering Real-World Bidirectional Scattering Distribution Functions. LBNL-5954E. October 2012. <http://eetd.lbl.gov/node/51625>.
- Ward, G. 2013. Qualitative evaluation of BSDF measurement interpolation in Radiance. DOE Technical Memo., September 30, 2013.
- Webster, T., D. Dickerhoff, D. Heinzerling, F. Bauman, T. Hoyt, B. Coffey, E.S. Lee, L.L. Fernandes, A. McNeil, and T. Nouidui. 2013. "The New York Times Building Post-Occupancy Evaluation: Simulation Model Calibration." Appendix 3.2.4 in Bauman, F. et al., "Advanced Integrated Systems Technology Development", Final Report for California Energy Commission, Energy Research and Development Division.
- Wen, Y. J. 2011a. Rapid Prototyping Control Implementation using the Building Controls Virtual Test Bed. Philips Technical Report. September 30, 2011.
- Wen, Y. J., F. M. Rubinstein, and D. L. DiBartolomeo. 2011b. Co-simulation Based Building Controls Implementation with Networked Sensors and Actuators. Proceedings of BuildSys 2011, Third ACM Workshop on Embedded Sensing Systems for Energy-Efficiency in Buildings. Seattle, Washington. November 1, 2011.
- Wetter, M. GenOpt Generic Optimization Program, User Manual, Version 3.1.0. Simulation Research Group, Lawrence Berkeley National Laboratory. December 8, 2011.
- Wetter, M., et al. 2014. Modelica Buildings Library. <http://simulationresearch.lbl.gov/modelica>.
- Wetter, M., and P. Haves. 2008. A Modular Building Controls Virtual Test Bed for the Integration of Heterogeneous Systems. Proceedings of SimBuild, 2008Xia, J., Y Ying, and S. H. Foulger. 2005. "Electric-Field-Induced Rejection-Wavelength Tuning of Photonic-Bandgap Composites." *Advanced Materials* 17 (2005): 2463–2467.
- Zuo, W., A. McNeil, M. Wetter, and E. S. Lee. 2013. "Acceleration of the Matrix Multiplication of Radiance Three Phase Daylighting Simulations with Parallel Computing on

Heterogeneous Hardware of Personal Computer." *Journal of Building Performance Simulation* 7(2): 152–163.